User's Reference

Publication number 16556-97007
February 1999

For Safety information, Warranties, and Regulatory information, see the pages behind the Index.

© Copyright Hewlett-Packard Company 1992-1999
All Rights Reserved

HP 16556A and HP 16556D 100-MHz State/ 400-MHz Timing Logic Analyzer

In This Book

The User's Reference manual contains field and feature definitions. Use this manual to learn what the menu fields do, what they are used for, and how the features work.

The manual is divided into chapters covering general product information, probing, and separately tabbed chapters for each analyzer menu. Chapters on error messages and instrument specifications are also provided.

In the Configuration menu you have the choice of configuring an analyzer as either a State analyzer or a Timing analyzer. Some menus in the analyzer will change depending on the analyzer type you choose. For example, because a Timing analyzer does not use external clocks, the clock assignment fields in the Format menu will not be available.

If a menu field is only available to a particular analyzer type, the field is designated (Timing only) or (State only) after the field name. If no designation is shown, the field is available for both types.

1	General Information	
2	Probing	
3	The Configuration Menu	
4	The Format Menu	
5	The Trigger Menu	
6	The Listing Menu	
7	The Waveform Menu	
8	The Chart Menu	
9	The Compare Menu	
10	The Mixed Display Menu	
11	The SPA Menu	
12	Error Messages	
13	Specifications and Characteristics	
14	Installation	
	Index	

1 General Information

- User Interface 1-3
- Configuration Capabilities 1-4
- Key Features for the HP 16556A 1-5
- Key Features of the HP 16556D 1-5
- Accessories Supplied 1-6
- Accessories Available 1-7

2 Probing



- General-Purpose Probing System Description 2-17
- Assembling the Probing System 2-21
- Connecting the External Reference Clock 2-25

3 The Configuration Menu

- Analyzer Name Field 3-3
- Analyzer Type Field 3-4
- Unassigned Pods List 3-6
- Activity Indicators 3-8

4 The Format Menu

- State Acquisition Mode Field (State only) 4-3
- Timing Acquisition Mode Field (Timing only) 4-4
- Data on Clocks Display 4-5
- Pod Field 4-6
- Pod Clock Field (State only) 4-7
- Pod Threshold Field 4-10
- Master and Slave Clock Field (State only) 4-11
- Setup/Hold Field (State only) 4-13
- Symbols Field 4-15
- Label Assignment Fields 4-15
- Rolling Labels and Pods 4-15
- Label Polarity Fields 4-16
- Bit Assignment Fields 4-17

5 The Trigger Menu

Predefined Trigger Macros 5-3

Timing Trigger Macro Library 5-5

State Trigger Macro Library 5-7

Sequence Levels 5-9

Sequence Level Number Field 5-10

Sequence Instruction Menu 5-11

Resource Terms 5-16

Resource Term Fields 5-17

Bit Pattern Terms 5-20

Range Terms 5-22

Timer Terms 5-24

Edge Terms (Timing only) 5-26

Combination of Terms 5-28

Control Fields 5-30



Arming Control Field 5-31

Count Field (State and State Compare only) 5-34

Acquisition Control Field 5-36

Modify Trigger Field 5-40

6 The Listing Menu

Markers Field 6-3

Pattern Markers 6-4

Find X-pattern / O-pattern Field 6-5

Pattern Occurrence Fields 6-6

From Trigger / Start / X Marker Field 6-7

Specify Patterns Field 6-8

Label / Base Roll Field 6-11

Stop Measurement Field	6-12
Clear Pattern Field	6-14
Time Markers	6-15
Trig to X / Trig to O Fields	6-16
Statistics Markers	6-17
Data Roll Field	6-19

7 The Waveform Menu

Basic Controls	7-3
Acquisition Control Field	7-4
Accumulate Field	7-5
States Per Division Field (State and State Compare only)	7-6
Seconds Per Division Field (Timing only)	7-7
Delay Field	7-8
Sample Period Display (Timing only)	7-9
Markers Field	7-11
Pattern Markers	7-12
X-pat / O-pat Occurrence Fields	7-13
From Trigger / Start / X Marker Field	7-14
Center Screen Field	7-15
Specify Patterns Field	7-16
Time Markers	7-17
Trig to X / Trig to O Fields	7-18
Marker Label / Base and Display	7-19
Statistics Markers	7-20

Waveform Display	7-22
Display Location Reference Line	7-23
Blue Bar Field	7-23
Channel Mode Field	7-24
Module and Label Fields	7-26
Action Insert/Replace Field	7-26
Delete and Delete All Fields	7-27
Waveform Size Field	7-28

8 The Chart Menu

The Y Markers	8-4
The X Markers and the Markers Field	8-5
Sample	8-5
Pattern	8-6
Rescale	8-13
Axis Control Field	8-15
Accumulate Field	8-18
Cancel Field	8-18

9 The Compare Menu

Reference Listing Field	9-4
Difference Listing Field	9-5
Copy Listing to Reference Field	9-7
Find Error Field	9-8
Compare Full / Compare Partial Field	9-9
Mask Field	9-10
Specify Stop Measurement Field	9-11
Data Roll Field	9-14
Bit Editing Field	9-15
Label and Base Fields	9-16
Label / Base Roll Field	9-16

10 The Mixed Display Menu

- Intermodule Configuration 10-3
- Inserting Waveforms 10-4
- Interleaving State Listings 10-4
- Time-Correlated Displays 10-5
- Markers 10-5

11 The SPA Menu

- System Performance Analysis Software 11-2
- What is System Performance Analysis? 11-4
- Getting Started 11-6
- SPA Measurement Processes 11-8
- Using State Overview, State Histogram, and Time Interval 11-21
- Using SPA with other features 11-30

12 Error Messages

- Error Messages 12-3
- Warning Messages 12-4
- Advisory Messages 12-7

13 Specifications and Characteristics

- Specifications 13-3
- Characteristics 13-4
- Supplemental Characteristics 13-5

14 Installation

- To configure a single-card module 14-2
- To configure a multi-card module 14-3
- To install modules 14-8
- Preparing for Use 14-9
- To inspect the module 14-10
- To clean the logic analyzer module 14-10



General Information

Logic Analyzer Description

The HP 16556 State/Timing Analyzer module is part of a new generation of general-purpose logic analyzers. It is used with the HP 16500 Logic Analysis System, which is designed as a standalone instrument for use by digital and microprocessor hardware and software designers. The HP 16500 mainframe has HP-IB and RS-232-C interfaces for hard copy printouts and control by a host computer.

The State/Timing Analyzer module has 64 data channels, and four clock/data channels. As many as four additional HP 16556 cards can be added to expand the module to 336 data and 4 clock/data channels.

Memory depth on the HP 16556A is 1M in all pod pair groupings, or 2M on just one pod (half channels). For HP 16556D, memory depth is 2M in all pod pairs, or 4M on just one pod. All available resource terms can be assigned to either configured state or timing analyzer machine.

Measurement data is displayed as data listings or waveforms.

The 100-MHz state analyzer has master, slave, and demultiplexed clocking modes available. Measurement data can be stamped with either state or time tags. For triggering and data storage, the state analyzer uses 12 sequence levels with two-way branching, 10 pattern resource terms, 2 range terms, and 2 timers/counters.

The 400-MHz conventional timing analyzer has variable width, depth, and speed selections. Sequential triggering uses 10 sequence levels with two-way branching, 10 pattern resource terms, 2 range terms, 2 timers/counters and 2 edge/glitch terms.



User Interface

The HP 16500 Logic Analysis System has four easy-to-use user interface devices: the knob, the touchscreen, the mouse, and the optional keyboard.

The knob on the front panel is used to move the cursor on certain menus, to increment or decrement numeric fields, and to roll the display.

The touchscreen fields can be selected by touch or with the mouse. To activate a touchscreen field by touch, simply press the screen over any dark blue box on the display with your finger until the field changes color. Then remove your finger from the screen to activate your selection.

To activate a field with the mouse, position the cursor (+) of the mouse over the desired field and press the button on the upper-left corner of the mouse.

The optional keyboard can control all instrument functions by using special function keys, the arrow keys, and the ENTER key. Alphanumeric entry is simply typed in.

All user interface devices are discussed in more detail in the *HP 16500 User's Reference*.

Configuration Capabilities

The HP 16556A and HP 16556D can be configured as a single-card or up to a five-card system. Within a multi-card system, all cards must be of the same model. The number of data channels ranges from 68 channels using just one card, to 336 channels when five cards are cabled together. A half-channel timing acquisition mode is available which reduces the channel width by half, but doubles memory depth from 1M-deep to 2M-deep per channel on the HP 16556A, or from 2M-deep to 4M-deep per channel on the HP 16556D.

Modules are made of cards cabled together to form a single timebase. Because the clock is common to all cards in a module, the data is always synchronized. For tightly coupled measurements involving multiple HP 16556 modules, your analyzer module provides an external reference clock. The reference clock prevents large data samples from becoming unsynchronized towards the end of a measurement. Because the internal clock on each logic analyzer card is accurate to 100 parts per million, in a 2M timing measurement using two separate modules, the last sample of each may be separated as much as 100 times the sample period. The external reference clock prevents this by having multiple modules share the same clock. There is no limit to how many modules may share the clock.

See Also

"Connecting the External Reference Clock" in chapter 2, Probing, for information on configuring the external reference clock.



Key Features for the HP 16556A

- 100-MHz state and 400-MHz timing acquisition speed.
- 64 data channels/4 clocks expandable to 336 data/4 clock channels.
- Lightweight passive probes for easy hookup and compatibility with previous HP logic analyzers and preprocessors.
- HP-IB and RS-232-C interface for programming and hard copy printouts.
- Variable setup/hold time, 3.5-ns window.
- External arming to and from other modules through the intermodule bus.
- 1-M deep memory on all channels with 2 M in half-channel modes.
- Marker measurements.
- 12 levels of trigger sequencing for state and 10 levels of sequential triggering for timing.
- Both state and timing analyzers can use 10 pattern resource terms, two range terms, and two timer/counters to qualify and trigger on data. The timing analyzer also has two edge terms available.
- Time (10-ns resolution) and number-of-qualified-states tagging.
- Full programmability.
- Mixed State/Timing and State/State (interleaved) display.
- Waveform display.

Key Features of the HP 16556D

As above, but 2-M deep memory on all channels with 4 M in half-channel modes.

Accessories Supplied

The table below lists the accessories supplied with your logic analyzer. If any of these accessories are missing, contact your nearest Hewlett-Packard Sales Office. If you need additional accessories, refer to the *Accessories for HP Logic Analyzers* brochure.

Table 1-1

Accessories Supplied

Accessory	HP Part No.	Quantity
Probe tip assemblies	01650-61608	4
Probe cables	16555-61608	2
Grabbers (20 per pack)	5090-4356	4 pkgs
Extra probe leads (5 per pack)	5959-9333	1 pkg
Probe cable and pod labels	01650-94310	1
Probe cable ID clip	16500-41201	4
Double probe adapter	16542-61607	1
External reference cable	16555-61608	1
Ferrite Instructions	16555-92000	1
Ferrite Cores	16555-60001	2
Probe grounds (5 per pack)	5959-9334	4
Operating system disks	Call	1
User's Reference	Call	1



Accessories Available

There are a number of accessories available that will make your measurement tasks easier and more accurate. You will find these listed in *Accessories for HP Logic Analyzers*.

Preprocessor Modules

The preprocessor module accessories enable you to quickly and easily connect the logic analyzer to your microprocessor under test.

Included with each preprocessor module is a 3.5-inch disk which contains a configuration file and an inverse assembler file. When you load the configuration file, it configures the logic analyzer for making state measurements on the microprocessor for which the preprocessor is designed.

Configuration files from other analyzer modules can also be loaded. For information on translating other configuration files into the analyzer, refer to "Preprocessor File Configuration Translation and Pod Connections" in chapter 2, "Probing".

The inverse assembler file is a software routine that will display captured information in a specific microprocessor's mnemonics. The DATA field in the State Listing is replaced with an inverse assembly field. The inverse assembler software is designed to provide a display that closely resembles the original assembly language listing of the microprocessor's software. It also identifies the microprocessor bus cycles captured, such as Memory Read, Interrupt Acknowledge, or I/O write.

Many of the preprocessor modules require the HP 10269C General Purpose Probe Interface. The HP 10269C accepts the specific preprocessor PC board and connects it to five connectors on the general purpose interface to which the logic analyzer probe cables connect.

A list of preprocessor modules is found in the *Accessories for HP Logic Analyzers* brochure. Descriptions of the preprocessor modules are found with the preprocessor module accessories.



Probing

Probing

This chapter contains a description of the probing system for the logic analyzer. It also contains the information you need for connecting the probe system components to each other, to the logic analyzer, and to the system under test.

Probing Options

You can connect the logic analyzer to your system under test in one of the following ways:

- The standard general purpose probing (provided).
- HP E2445A User-Definable Interface (optional).
- Direct connection to a 20-pin, 3M-Series type header connector using the termination adapter (optional).
- Microprocessor and bus specific interfaces (optional).

General-Purpose Probing

General-purpose probing involves connecting the logic analyzer probes directly to your target system without using any interface. General purpose probing does not limit you to specific hook up schemes, as for example, the probe interface does. General-purpose probing uses grabbers that connect to both through hole and surface mount components.

General-purpose probing is the standard probing option provided with the logic analyzer. There is a full description of its components and use later in this chapter.

The HP E2445A User-Definable Interface

The optional HP E2445A User-Definable Interface allows you to connect the logic analyzer to the microprocessor in your target system. The HP E2445A includes a breadboard that you custom-wire for your system.

You will find additional information about the HP E2445A in the *Accessories for HP Logic Analyzers* brochure.

The Termination Adapter

The optional termination adapter allows you to connect the logic analyzer probe cables directly to test ports on your target system without the probes.

The termination adapter is designed to connect to a 20-pin (2x10), 4-wall, low-profile header connector, 3M-Series 3592 or equivalent.

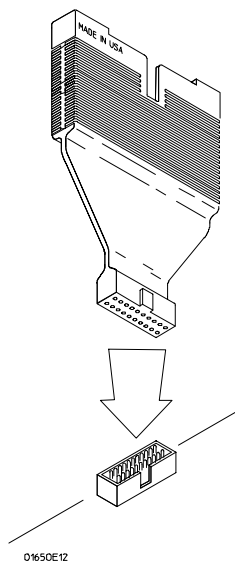

Termination Adapter

Microprocessor and Bus-Specific Interfaces

There are a number of microprocessor and bus-specific interfaces available as optional accessories which are listed in *Microprocessor and Bus Interfaces* and *Software Accessories for HP Logic Analyzers*. Microprocessors are supported by Universal Interfaces or Preprocessor Interfaces, or in some cases both.

Preprocessor interfaces are aimed at hardware turn-on and hardware/software integration, and will provide the following:

- All clocking and demultiplexing circuits needed to capture the system's operation.
- Additional status lines to further decode the operation of the CPU.
- Inverse assembly software to translate logic levels captured by the logic analyzer into microprocessor mnemonics.
- Bus interfaces to support bus analysis for HP-IB, RS-232-C, RS-449, SCSI, VME, VXI, ISA, EISA, MCA, FDDI, Futurebus+, JTAG, SBus, PCI, and PCMCIA.

Universal Interfaces are aimed at initial hardware turn-on, and will provide fast, reliable, and convenient connections to the microprocessor system. Universal Interfaces do not provide inverse assembly of software instructions.

Preprocessor File Configuration Translation and Pod Connections

Preprocessor configuration files from an HP 16550A can be used by the HP 16556A and 16556D logic analyzers. However, some pods must be connected differently in order for the configuration files to work properly. The tables on the next several pages provide information on what configuration files to load and the required connections between the preprocessor interface and the HP 16556A and 16556D pods.

In the tables, expansion and master card pods are referred to as either A or B pods. Those designations are done for convenience. The letter designation of pods in your system will depend on the slots in which your cards reside. They may use any letter from A through E for the 16500 Logic Analysis System mainframe, or F through J for the 16501A Expander Frame

In a five-card system, for example, the master card pods would be labeled C. The expansion card pods then would be labeled A, B, D, and E. Look at the Format menu for the slot designators for expansion cards in your system.

The following three tables provide configuration file names and pod connections for older microprocessors. Look in the microprocessor-specific preprocessor manual for configuration and connection information for newer microprocessors.

Software and Hardware Translation Information

Table 2-1

Single-card HP 16550A configuration loaded into single-card HP 16556A or HP 16556D

HP Model	Processor	16550A Config Filename	Master Card Pods				Clocks	Drop Pods
			B4	B3	B2	B1		
10300B	Z80	FZ80	--	P2	--	P1	J+L	No
Inverse Assembler Labels: P1=DATA/STAT.clk P2=ADDR.clk								
10304B	8085	C8085_IF	--	P3	P2	P1	J, K mclk, sclk	No
Inverse Assembler Labels: P1=DATA/STAT.master_clk P2=ADDR.slave_clk								
10305B	8086	F8086_I	P3	P2	--	P1	J	No
Inverse Assembler Labels: P1=DATA.clk P2=ADDR P3=ADDR/STAT								
10305B	8088	F8088_I	P3	P2	--	P1	J	No
Inverse Assembler Labels: P1=DATA.clk P2=ADDR P3=ADDR/STAT								
10315G/H	68HC11	F68HC11	--	P2	--	P1	L, J mclk, sclk	Timing P3, P4
Inverse Assembler Labels: P1=ADDR/DATA.slave_clk P2=ADDR/STAT.master_clk								
10341B	1553	F1553	--	P2	--	P1	J	Timing P3
Inverse Assembler Labels: P1=DATA.clk (no Inverse Assembler capability)								
10342B	RS232	FRS232	--	P3	P4	P1	K	No
Inverse Assembler Labels: P1=DATA/STAT P4=.clk								
10342B	HPIB	FHPIB	.		P3	P2	J	No
Inverse Assembler Labels: P2=DATA/STAT.clk P3=DATA								

Table 2-1 (continued)

Single-card HP 16550A configuration loaded into single-card HP 16556A or HP 16556D

HP Model	Processor	16550A Config Filename	Master Card Pods				Clocks	Drop Pods
			B4	B3	B2	B1		
10342G	HPIB	FHPIB	--	J2	--	J2	J	No
Inverse Assembler Labels: J2=DATA/STAT.clk								
E2409B	80286	F80286S	P3	P2	--	P1	J	Timing
Inverse Assembler Labels: P1=Data.clk P2=ADDR P3=ADDR/STAT								
E2409B	80286	F80286T	P3	P2	--	P4	Timing	Timing
Inverse Assembler Labels: n/a								
E2413B	68331/2	F68332	P4	P3	P5	P1	J	State
Inverse Assembler Labels: P1=DATA.clk P3=ADDR P4=ADDR P5=STAT								
E2414B	68302	F68302	--	P4	P3	P1	J	No
Inverse Assembler Labels: P1=DATA.clk P3=ADDR P4=ADDR/STAT								
E2415A	MCS-51	FMCS51	--	P2	P3	P1	J	State
Inverse Assembler Labels: P1=DATA.clk P2=ADDR P3=STAT								
E2416A	MCS-96	FMCS96	--	P3	P2	P1	J	No
Inverse Assembler Labels: P1=DATA.clk P2=ADDR P3=STAT								
E2418A	320C20/25	F320C25	J3	J1	--	J2	J	No
Inverse Assembler Labels: J1=DATA J2=ADDR.clk J3=STAT								
E2419A	68HC16	FHC16	P4	P3	P5	P1	J	State
Inverse Assembler Labels: P1=DATA.clk P3=ADDR P5=STAT (P4=ADDR not required)								

Table 2-1 (continued)

Single-card HP 16550A configuration loaded into single-card HP 16556A or HP 16556D

HP Model	Processor	16550A Config Filename	Master Card Pods				Clocks	Drop Pods
			B4	B3	B2	B1		
E2423A	SCSI-2	FSCSI2	P4	P3	P2	P1	J	No
Inverse Assembler Labels: P1=STAT.clk P2=ADDR/DATA								
E2424B	68340	F68340	P4	P3	P5	P1	K	No
Inverse Assembler Labels: P1=DATA P3=ADDR P5=STAT.clk (P4=ADDR_B not required)								
E2424B	68340	FEV340	P4	P3	P5	P1	J	No
Inverse Assembler Labels: P1=DATA.clk P3=ADDR P5=STAT (P4=ADDR not required)								
E2431A	320C30/31	P_320C3X	P4	P3	P2	P1	J↓	No
Inverse Assembler Labels: P1=DATA.clk P2=DATA P3=ADDR P4=ADDR/STAT								
E2431A	320C30/31	Q_320C30	P6	P5	--	P7	J↓	No
Inverse Assembler Labels: P5=DATA P6=DATA P7=ADDR/STAT.clk								
Note: A single-card HP 16556 is not recommended for this preprocessor because it does not allow simultaneous viewing of both the primary and expansion microprocessor buses.								
E2434A	80186XL/88	C186EA09	P4	P3	--	P1	J	No
Inverse Assembler Labels: P1=DATA.clk P3=ADDR P4=ADDR/STAT								
E2434A	80186XL/88	C186EA10	P6	P5	P4	P2	Timing	No
Inverse Assembler Labels: n/a								
E2434B	80186/88EB	C186EB_7	P4	P3	--	P1	J	No
Inverse Assembler Labels: P1=DATA.clk P3=ADDR P4=ADDR/STAT								
E2434B	80186/88EB	C186EB_8	P6	P5	P4	P2	Timing	Timing P7
Inverse Assembler Labels: n/a								

Table 2-1 (continued)

Single-card HP 16550A configuration loaded into single-card HP 16556A or HP 16556D

HP Model	Processor	16550A Config Filename	Master Card Pods				Clocks	Drop Pods
			B4	B3	B2	B1		
E2434C	80186/88EC	C186EC_7	P4	P3	P6	P1	J	No
Inverse Assembler Labels: P1=DATA.clk P3=ADDR P4=ADDR/STAT								
E2434C	80186/88EC	C186EC_8	P5	P6	P7	P2	Timing	Timing
Inverse Assembler Labels: n/a								
E2442A	TMS320C5X	D_320C5X	P5	P2	P3	P1	J+K+L	State
Inverse Assembler Labels: P1=DATA.clk P2=STAT.clk P3=ADDR.clk								
E2447AA	68000	F68000	P6	P1	P4	P3	K	No
Inverse Assembler Labels: P1=DATA P3=ADDR P4=ADDR/STAT.clk								
E2447AA	68010	F68010	P6	P1	P4	P3	K	No
Inverse Assembler Labels: P1=DATA P3=ADDR P4=ADDR/STAT.clk								
E2447AB	68EC000	FEC000	P6	P1	P4	P3	K	No
Inverse Assembler Labels: P1=DATA P3=ADDR P4=ADDR/STAT.clk								
E2451A	Ethernet	CETH_4	P4	P3	P2	P1	J	No
Inverse Assembler Labels: P1=DATA.clk P2=ADDR/DATA_B P3=ADDR/DATA_B P4=STAT								
E2453A	DS1	C_DS1_6	.	--	xx		J↓	No
Inverse Assembler Labels: Carrier/Customer=ADDR/DATA/STAT.clk								
E2453A	DS1	C_DS1_7	--	Cu	--	Ca	J↓ L↓	No
mach2 mach1 mach1 mach2								
Inverse Assembler Labels: Carrier=ADDR/DATA/STAT.clk Customer=ADDR/DATA/STAT.clk								

Table 2-2

Single-card HP 16550A configuration loaded into multi-card HP 16556A or HP 16556D

HP Model	Processor	16550A Config Filename	Expansion Card Pods				Master Card Pods				Clocks	Drop Pods
			A4	A3	A2	A1	B4	B3	B2	B1		
10300B	Z80	FZ80					--	P2	--	P1	J+L	No
Inverse Assembler Labels: P1=DATA/STAT.clk P2=ADDR.clk												
10304B	8085	C8085_IF	.		--	P3	.		P2	P1	J, K mclk, sclk	No
Inverse Assembler Labels: P1=DATA/STAT.master_clk P2=ADDR.slave_clk												
10305B	8086	F8086_I	.		P3	P2	.	--	P1		J	No
Inverse Assembler Labels: P1=DATA.clk P2=ADDR P3=ADDR/STAT												
10305B	8088	F8088_I	.		P3	P2	.	--	P1		J	No
Inverse Assembler Labels: P1=DATA.clk P2=ADDR P3=ADDR/STAT												
10315G/H	68HC11	F68HC11					--	P2	--	P1	L, J mclk, sclk	Timing P3, P4
Inverse Assembler Labels: P1=ADDR/DATA.slave_clk P2=ADDR/STAT.master_clk												
10341B	1553	F1553	.		--	P2	--	P3	--	P1	J	No
Inverse Assembler Labels: P1=DATA.clk (no Inverse Assembler capability)												
10342B	RS232	FRS232					--	P3	P4	P1	K	No
Inverse Assembler Labels: P1=DATA/STAT P4=.clk												
10342B	HPIB	FHPIB					.		P3	P2	J	No
Inverse Assembler Labels: P2=DATA/STAT.clk P3=DATA												
10342G	HPIB	FHPIB					--	J2	---	J2	J	No
Inverse Assembler Labels: J2=DATA/STAT.clk												

Table 2-2 (continued)

Single-card HP 16550A configuration loaded into multi-card HP 16556A or HP 16556D

HP Model	Processor	16550A Config Filename	Expansion Card Pods				Master Card Pods				Clocks	Drop Pods
			A4	A3	A2	A1	B4	B3	B2	B1		
E2409B	80286	F80286S	P5	P4	P3	P2	.	--	P1	J	No	
Inverse Assembler Labels: P1=DATA.clk P2=ADDR P3=ADDR/STAT												
E2409B	80286	F80286T	.		P5	P4	P3	P2		Timing	No	
Inverse Assembler Labels: n/a												
E2413B	68331/2	F68332	P6	P5	P4	P3	.	P2	P1	J	No	
Inverse Assembler Labels: P1=DATA.clk P3=ADDR P4=ADDR P5=STAT												
E2414B	68302	F68302	--	P4	--	P3	.	--	P1	J	No	
Inverse Assembler Labels: P1=DATA.clk P3=ADDR P4=ADDR/STAT												
E2415A	MCS-51	FMCS51	P5	P3	--	P2	.	--	P1	J	No	
Inverse Assembler Labels: P1=DATA.clk P2=ADDR P3=STAT												
E2416A	MCS-96	FMCS96	.		--	P3	.	P2	P1	J	No	
Inverse Assembler Labels: P1=DATA.clk P2=ADDR P3=STAT												
E2418A	320C20/25	F320C25	--	J3	--	J1	.	--	J2	J	No	
Inverse Assembler Labels: J1=DATA J2=ADDR.clk J3=STAT												
E2419A	68HC16	FHC16	P6	P5	P4	P3	.	P2	P1	J	No	
Inverse Assembler Labels: P1=DATA.clk P3=ADDR P5=STAT (P4=ADDR not required)												
E2419A	68HC16EVB	FHC16	P6	P5	P3	P1	.	P4	P2	J	No	
Inverse Assembler Labels: P2=DATA.clk P1=ADDR P5=STAT (P3=ADDR not required)												

Table 2-2 (continued)

Single-card HP 16550A configuration loaded into multi-card HP 16556A or HP 16556D

HP Model	Processor	16550A Config Filename	Expansion Card Pods				Master Card Pods				Clocks	Drop Pods
			A4	A3	A2	A1	B4	B3	B2	B1		
E2423A	SCSI-2	FSCSI2					P4	P3	P2	P1	J	No
Inverse Assembler Labels: P1=STAT.clk P2=ADDR/DATA												
E2424B	68340	F68340	P4	P3	--	P1	.	--	P5	J		No
Inverse Assembler Labels: P1=DATA P3=ADDR P5=STAT.clk (P4=ADDR_B not required)												
E2424B	68340	FEV340	--	P5	P4	P3	.	--	P1	J		No
Inverse Assembler Labels: P1=DATA.clk P3=ADDR P5=STAT (P4=ADDR not required)												
E2431A	320C30/31	O_320C30	--	P7			P2	P1	P4	P3	J \uparrow +L \downarrow	No
Inverse Assembler Labels: P1=DATA.clk P2=DATA P3=ADDR.clk P4=ADDR/STAT P7=STAT												
Note: This is actually an HP 16510 configuration file.												
E2434A	80186XL/88	C186EA09	.	P4	P3	.	--	P1	J			No
Inverse Assembler Labels: P1=DATA.clk P3=ADDR P4=ADDR/STAT												
E2434A	80186XL/88	C186EA10	.	P6	P5	P4	P2				Timing	No
Cable Mapping: 1-B3 2-B4 3-A1 4-A2 5-B1 6-B2												
Inverse Assembler Labels: n/a												
E2434B	80186/88EB	C186EB_7	.	P4	P3	.	--	P1	J			No
Inverse Assembler Labels: P1=DATA.clk P3=ADDR P4=ADDR/STAT												
E2434B	80186/88EB	C186EB_8	--	P7	P6	P5	P4	P2			Timing	No
Inverse Assembler Labels: n/a												
E2434C	80186/88EC	C186EC_7	.	P4	P3	.	P6	P1	J			No
Inverse Assembler Labels: P1=DATA.clk P3=ADDR P4=ADDR/STAT												
E2434C	80186/88EC	C186EC_8	--	P8	P5	P6	P7	P2			Timing	No
Inverse Assembler Labels: n/a												

Table 2-2 (continued)

Single-card HP 16550A configuration loaded into multi-card HP 16556A or HP 16556D

HP Model	Processor	16550A Config Filename	Expansion Card Pods				Master Card Pods				Clocks	Drop Pods
			A4	A3	A2	A1	B4	B3	B2	B1		
E2442A	TMS320C5X	D_320C5X	.		--	P4	P5	P2	P3	P1	J+K+L	No
Inverse Assembler Labels: P1=DATA.clk P2=STAT.clk P3=ADDR.clk												
E2447AA	68000	F68000	.		P6	P1	.	P4	P3		K	No
Inverse Assembler Labels: P1=DATA P3=ADDR P4=ADDR/STAT.clk												
E2447AA	68010	F68010	.		P6	P1	.	P4	P3		K	No
Inverse Assembler Labels: P1=DATA P3=ADDR P4=ADDR/STAT.clk												
E2447AB	68EC000	FEC000	.		P6	P1	.	P4	P3		K	No
Inverse Assembler Labels: P1=DATA P3=ADDR P4=ADDR/STAT.clk												
E2451A	Ethernet	CETH_4	.		P4	P3	.	P2	P1		J	No
Inverse Assembler Labels: P1=DATA.clk P2=ADDR/DATA_B P3=ADDR/DATA_B P4=STAT												
E2453A	DS1	C_DS1_6	.				.	--	xx		J↑	No
Inverse Assembler Labels: Carrier/Customer=ADDR/DATA/STAT.clk												
E2453A	DS1	C_DS1_7	.				--	Cu	--	Ca	J↑ L↑	No
mach2 mach1 mach1 mach2												
Inverse Assembler Labels: Carrier=ADDR/DATA/STAT.clk Customer=ADDR/DATA/STAT.clk												

Table 2-3

Two-card HP 16550A configuration loaded into multi-card HP 16556A or HP 16556D (or single-card HP 16550 which requires more than four pods for inverse assembly)

HP Model	Processor	16550A Config Filename	Expansion Card Pods				Master Card Pods				Clocks	Drop Pods
			A4	A3	A2	A1	B4	B3	B2	B1		
E2401A	R3000	FR3KA	--	P7	P6	P5	P4	P3	P2	P1	J \uparrow	No
Inverse Assembler Labels: P1=STAT.clk P2=DATA P3=DATA P4=ADDR/STAT P5=ADDR P6=ADDR P7=STAT FR3KB Same as FR3KA FR3KC Same as FR3KA												
E2403A	80486	UI_486_21	--	J4	J6	J7	J3	J5	J1	J2	J	No
E2406A	68030	C68030_4	.	P5	P4	--	P3	P2	P1		K+L	No
Inverse Assembler Labels: P1=DATA P2=DATA.clk P3=STAT.clk P4=ADDR P5=ADDR												
E2411C	80486	F486S2	--	P7	P6	P5	P4	P3	P2	P1	(J)*(K=1)	No
Inverse Assembler Labels: P1=STAT.clk P2=STAT.clk P3=DATA P4=DATA P5=ADDR P6=ADDR												
E2412A	I860XP	F_I860XP	P6	P5	P9	P8	P3	P2	P7	P1	J	No
Inverse Assembler Labels: P1=STAT.clk P2=DATA P3=DATA P5=DATA_B P6=DATA_B P7=STAT P8=ADDR P9=ADDR												
E2420A	68040	F68040	P4	P3	P2	P1	.	--	P5		J	No
Inverse Assembler Labels: P1=ADDR P2=ADDR P3=DATA P4=DATA P5=STAT.clk												
E2426A/B	68020	F68020E	P6	P5	P2	P1	.	P4	P3		J	No
Inverse Assembler Labels: P1=DATA P2=DATA P3=ADDR.clk P4=ADDR P5=STAT (P6=STAT_B not accessed by inverse assembler)												
E2426A/B	68EC020	FEC020E	P6	P5	P2	P1	.	P4	P3		J	No
Inverse Assembler Labels: P1=DATA P2=DATA P3=ADDR.clk P4=ADDR P5=STAT (P6=STAT_B not accessed by inverse assembler)												

Table 2-3 (continued)

Two-card HP 16550A configuration loaded into multi-card HP 16556A or HP 16556D (or single-card HP 16550 which requires more than four pods for inverse assembly)

HP Model	Processor	16550A Config Filename	Expansion Card Pods				Master Card Pods				Clocks	Drop Pods	
			A4	A3	A2	A1	B4	B3	B2	B1			
E2432A	80960CA	PI960CA_06	--	P7	P5	P4		P3	P2	P6	P1	J↓	No
Inverse Assembler Labels: P1=STAT.clk P2=DATA P3=DATA P4=ADDR P5=ADDR													
E2435A	I860XR	I860XR3	--	P7	P6	P5		P3	P2	P4	P1	J	No
Inverse Assembler Labels: P1=STAT.clk P2=ADDR P3=ADDR P4=DATA_B P5=DATA P6=DATA P7=DATA_B													
E2438A	R4000	F_R4K	P6	P5	P4	P3		P8	P7	P2	P1	J↓+K	State
P9 Inverse Assembler Labels: P1=STAT.clk P2=STAT.clk P3=DATA P4=DATA P5=ADDR P6=ADDR P7=DATA_B P8=DATA_B													
E2441B	VME/VXI	FE2441	P6	P5	P4	P3	.		P2	P1		J	No
Inverse Assembler Labels: P1=DATA.clk P2=DATA P3=ADDR P4=ADDR P5=STAT													
E2443B	Pentium	CPENT_2	P6	P5	P4	P3		P8	P7	P2	P1	(J)*(K=0)	State
P9, P10 Inverse Assembler Labels: P1=STAT.clk P2=STAT.clk P3=ADDR P4=ADDR P5=DATA P6=DATA P7=DATA_B P8=DATA_B													
E2444A	80386DX	PI386_04	--	P5	P4	P3	.		P2	P1		J	No
Inverse Assembler Labels: P1=DATA.clk P2=DATA P3=ADDR P4=ADDR P5=STAT													

Table 2-3 (continued)

Two-card HP 16550A configuration loaded into multi-card HP 16556A or HP 16556D (or single-card HP 16550 which requires more than four pods for inverse assembly)

HP Model	Processor	16550A Config Filename	Expansion Card Pods				Master Card Pods				Clocks	Drop Pods
			A4	A3	A2	A1	B4	B3	B2	B1		
E2448A	68360	C68360_0	P6	P5	P4	P3	.	P2	P1	J	No	
^ Asynchronous Operation Inverse Assembler Labels: P1=STAT.clk P2=STAT P3=DATA P4=DATA P5=ADDR P6=ADDR												
E2448A	68360	C68360_4	.	P4	P3	P6	P5	P2	P1	J+L,K	No	
^Synchronous Operation Inverse Assembler Labels: P1=STAT.master_clk P2=STAT.slave_clk P3=DATA P4=DATA P5=ADDR.master_clk P6=ADDR												
E2457A	P54C	CP54C_2	P6	P5	P4	P3	P8	P7	P2	P1	(J)*(K=0)	State
P9, P10 Inverse Assembler Labels: P1=STAT.clk P2=STAT.clk P3=ADDR P4=ADDR P5=DATA P6=DATA P7=DATA_B P8=DATA_B												

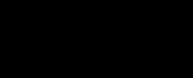

General-Purpose Probing System Description

The standard probing system provided with the logic analyzer consists of a probe tip assembly, probe cable, and grabbers. Because of the passive design of the probes, there are no active circuits at the outer end of the cable.

The passive probing system is similar to the probing system used with high-frequency oscilloscopes. It consists of a series RC network (90 k Ω in parallel with 8 pF) at the probe tip, and a shielded resistive transmission line. The advantages of this system include the following:

- 250 Ω in series with 8-pF input capacitance at the probe tip for minimal loading.
- Signal ground at the probe tip for higher speed timing signals.
- Inexpensive removable probe tip assemblies.

Probe Tip Assemblies

Probe tip assemblies allow you to connect the logic analyzer directly to the target system. This general-purpose probing is useful for discrete digital circuits. Each probe tip assembly, or pod, contains 16 probe leads (data channels), one clock lead, a pod ground lead, and a ground tap for each of the 16 probe leads.

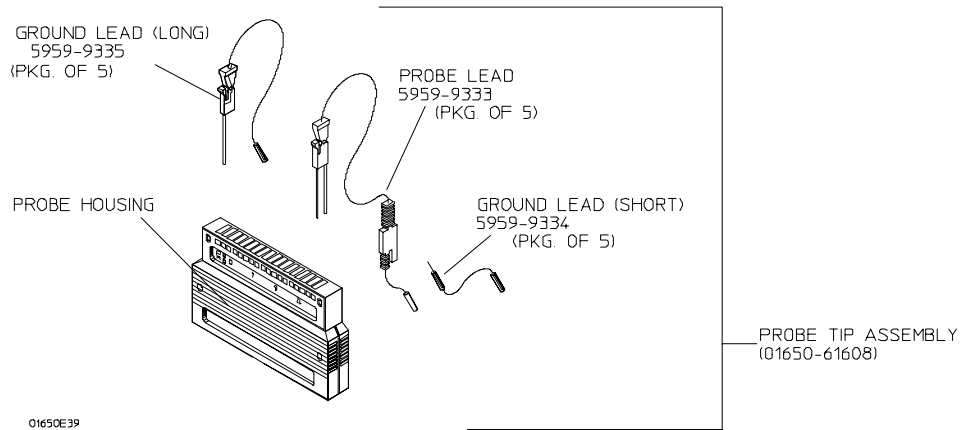

Probe Tip Assembly

Probe and Pod Grounding

Each pod is grounded by a long black pod ground lead. You can connect the ground lead directly to a ground pin on your target system or use a grabber. To connect the ground lead directly to grounded pins on your target system, you must use 0.63 mm (0.025 in) square pins, or use round pins with a diameter of 0.66 mm (0.026 in) to 0.84 mm (0.033 in). The pod ground lead should always be used.

Each probe can be individually grounded with a short black extension lead that connects to the probe tip socket. You can then use a grabber or the grounded pins on your target system in the same way you connect the data lines.

When probing signals with rise and fall times of 1 ns, grounding each probe lead with the 2-inch ground lead is recommended. In addition, always use the probe ground on a clock probe.

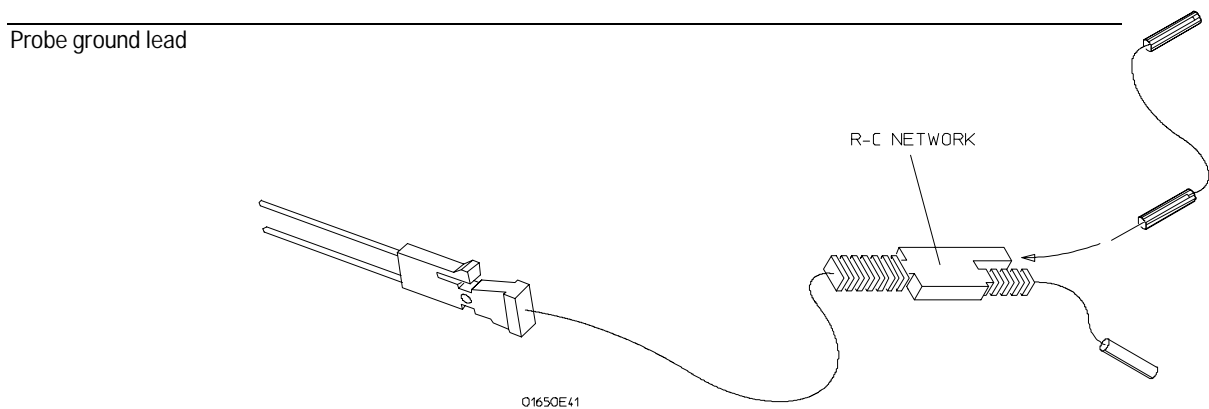

Probe Grounds



Probe Leads

The probe leads consists of a 12-inch twisted pair cable, a ground tap, and one grabber. The probe lead, which connects to the target system, has an integrated RC network with an input impedance of $100\text{ k}\Omega$ in parallel with approximately 8 pF , and all in series with $250\ \Omega$.

The probe lead has a two-pin connector on one end that snaps into the probe housing.

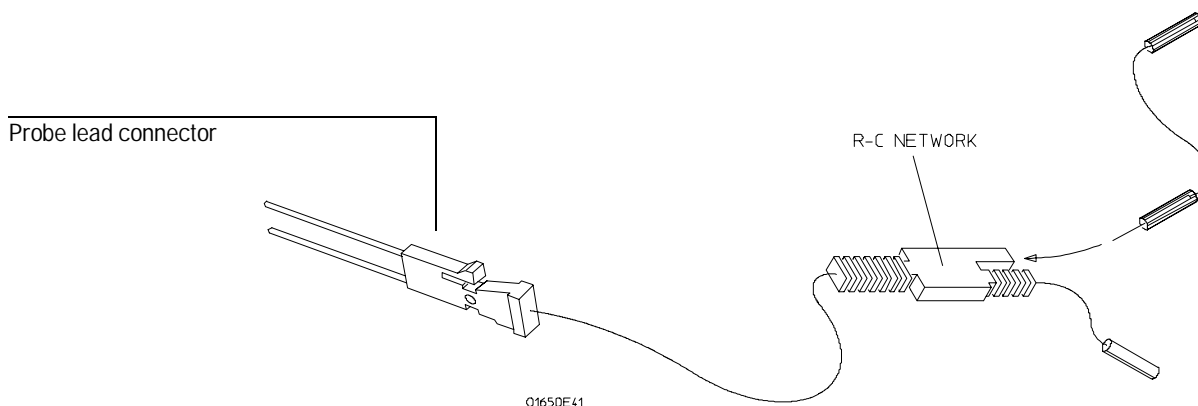

Probe Lead

Grabbers

The grabbers have a small hook that fits around the IC pins and component leads. The grabbers have been designed to fit on adjacent IC pins on either through-hole or surface-mount components with lead spacing greater than or equal to 0.050 in .

Probe Cable

The probe cable contains 18 signal lines, 17 chassis ground lines, and two power lines for preprocessor use. The cables are woven together into a flat ribbon that is 4.5 feet long. The probe cable connects the logic analyzer to the pods, termination adapter, HP 10269C General-Purpose Probe Interface, or preprocessor. Each cable is capable of carrying 0.33 amps for preprocessor power.

CAUTION

DO NOT exceed this 0.33 amps per cable or the cable will be damaged.

WARNING

Preprocessor power is protected by a current limiting circuit. If the current limiting circuit is activated, the fault condition must be removed. After the fault condition is removed, the circuit will reset in one minute.

Minimum Signal Amplitude

Any signal line you intend to probe with the logic analyzer probes must supply a minimum voltage swing of 500 mV to the probe tip. If you measure signal lines with a voltage swing of less than 500 mV, you may not obtain a reliable measurement.

Maximum Probe Input Voltage

The maximum input voltage of each logic analyzer probe is 40 volts peak.

Pod Thresholds

Logic analyzer pods have two preset thresholds and a user-definable threshold. The two preset thresholds are ECL (- 1.3 V) and TTL (+1.5 V). The user-definable threshold can be set anywhere between - 6.0 volts and +6.0 volts in 0.05-volt increments.

All pod thresholds are set independently.

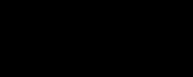

Assembling the Probing System

The general-purpose probing system components are assembled as shown below to make a connection between the measured signal line and the pods displayed in the Format menu.

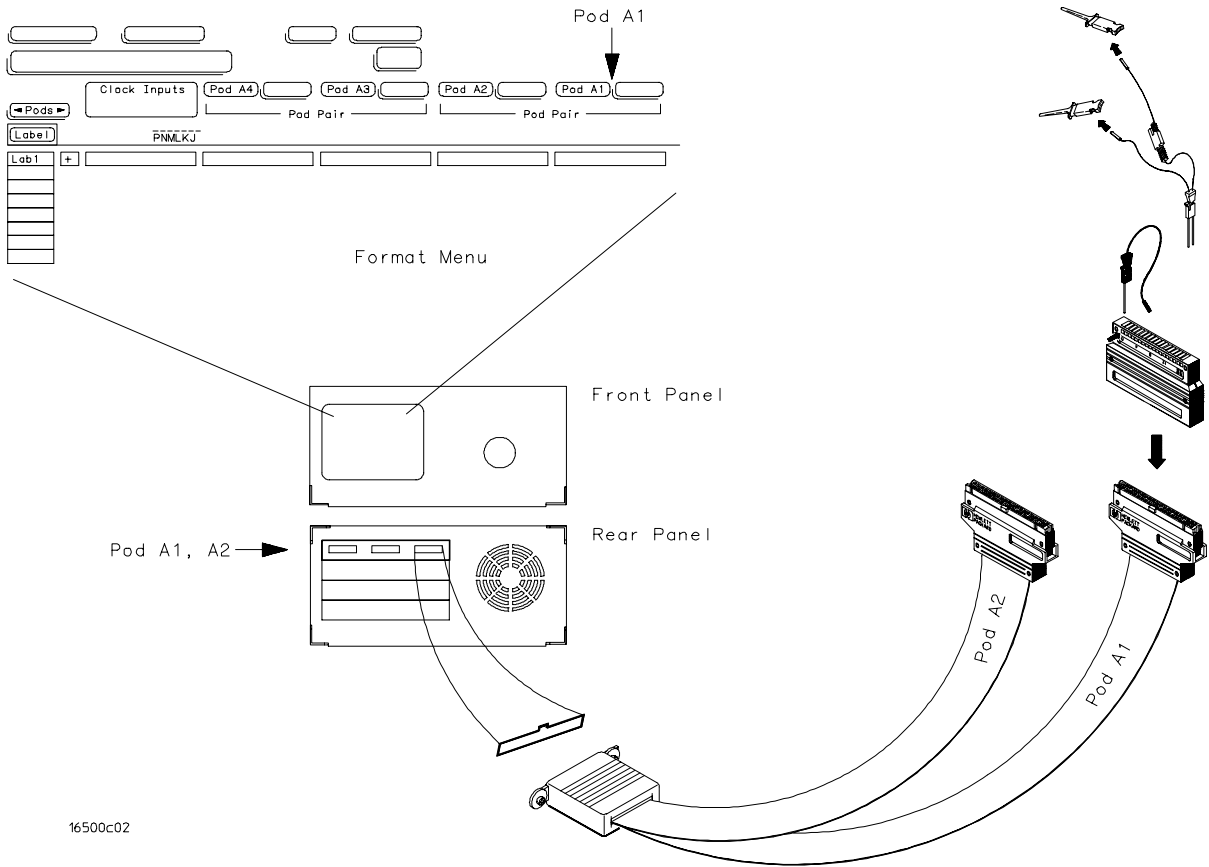

16500c02

Connecting Probe Cables to the Logic Analyzer

Connecting Probe Cables to the Logic Analyzer

All probe cables are installed at Hewlett-Packard. If you need to replace a probe cable, refer to the *Service Guide*, available from your HP Sales Office.

Connecting the Probe Tip Assembly to the Probe Cable

To connect a probe tip assembly to a cable, align the key on the cable connector with the slot on the probe housing and press them together.

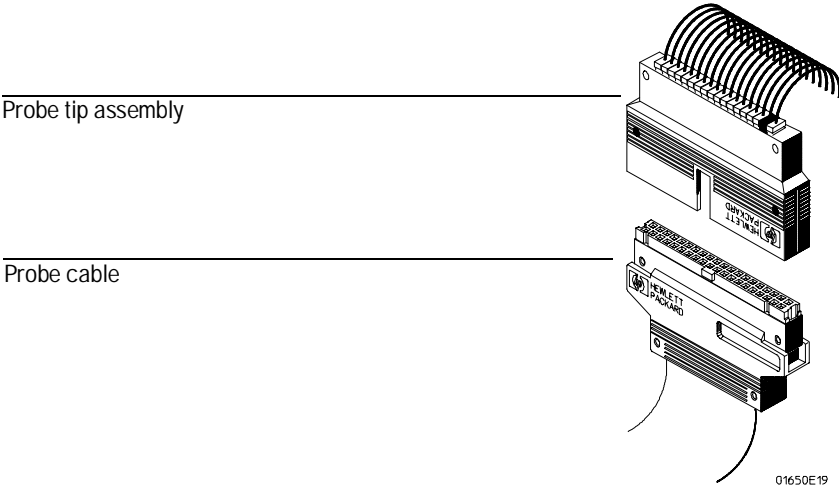

Connecting Probe Tip Assembly

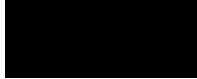

Disconnecting Probe Leads from Probe Tip Assemblies

When you receive the logic analyzer, the probe leads are already installed in the probe tip assemblies. To keep unused probe leads out of your way during a measurement, you can disconnect them from the pod.

To disconnect a probe, insert the tip of a ball-point pen into the latch opening. Push on the latch while gently pulling the probe out of the pod connector as shown in the figure below.

To connect the probes to the pods, insert the double pin end of the probe into the probe housing. Both the double pin end of the probe and the probe housing are keyed so they will fit together only one way.

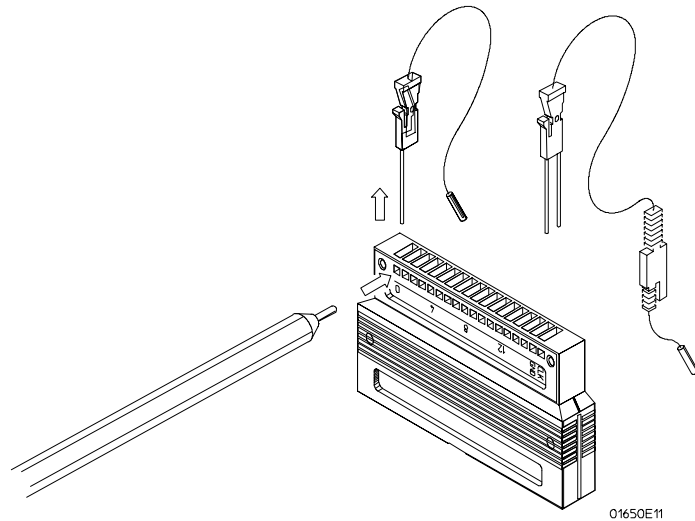

Installing Probe Leads

Connecting the Grabbers to the Probes

Connect the grabbers to the probe leads by slipping the connector at the end of the probe onto the recessed pin located in the side of the grabber. If you need to use grabbers for either the pod or the probe grounds, connect the grabbers to the ground leads in the same manner.

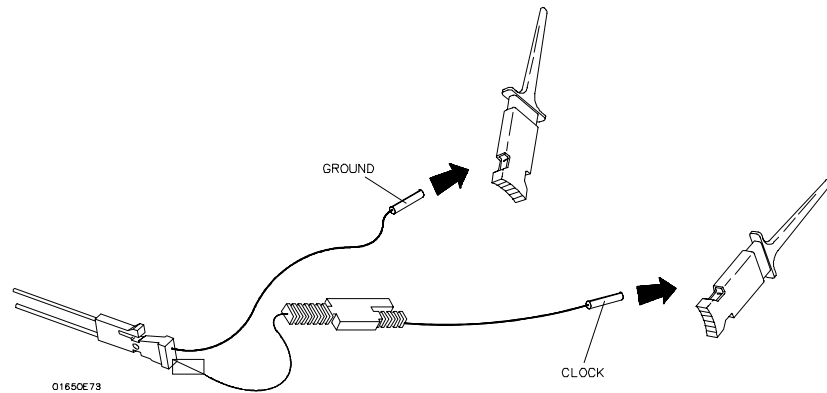

Connecting Grabbers to Probes

Connecting the Grabbers to the Test Points

The grabbers have a hook that fits around the IC pins and component leads. Connect the grabber to the test point by pushing the rear of the grabber to expose the hook. Hook the lead and release your thumb as shown.

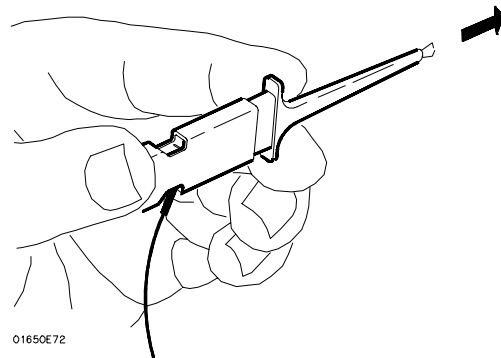

Connecting Grabbers to Test Points

Connecting the External Reference Clock

The external reference clock synchronizes deep-memory logic analyzer modules. Within a module, the individual cards all share a common clock and are thus automatically synchronized. However, each module clock is accurate only to 100 parts per million. So, two deep-memory logic analyzers with identical settings may capture their trigger at the same time but show discrepancies in the final sample. Sharing an external reference clock prevents this.

To Connect the External Reference Clock

You can either supply your own external reference clock, or choose one of the logic analyzer modules to supply the clock signal. Either method keeps all connected modules synchronized.

- 1 If you are supplying the clock signal, connect it to the "reference clock in" of the master card of the top module.



The Reference Clock field lets you specify whether to use the internal clock provided on the card, or an external clock. If you select the external clock, you must connect a clock signal to the card using the Reference Clock In/Out ports on the back of the analyzer.

CAUTION

Do not exceed 1 V, peak-to-peak, at a maximum voltage offset of 20 V on the Reference Clock In/Out ports.

- 2 Cable the top module's "reference clock out" to the "reference clock in" of the master card of the next module.
- 3 Continue connecting the modules in this manner.

Probing
Connecting the External Reference Clock

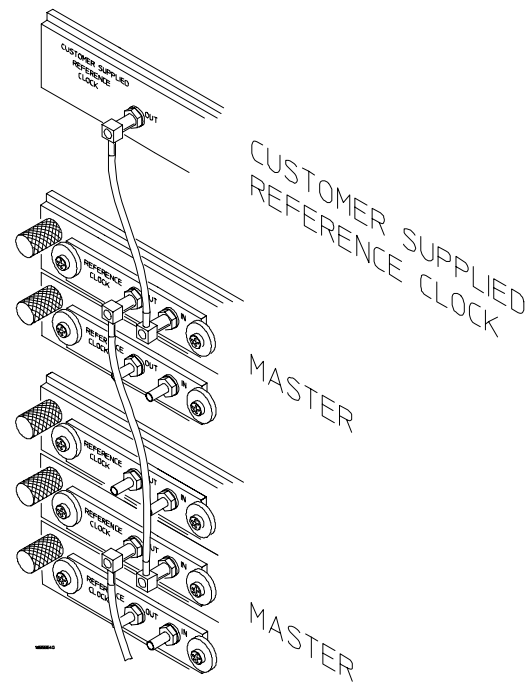

Connecting the External Reference Clock

Note that only the master card of a module should be connected. Connecting the clocks of the expander cards will not synchronize the module. Any number of modules may be synchronized together. Any modules that have external reference clock ports may be connected together.



The Configuration Menu

The Configuration Menu

The Configuration menu allows you to set module level parameters. You can partition the module into one or two independent analyzers. You can also assign pods to either analyzer, select the type of clocking needed (state or timing), and provide names for each analyzer.

The fields on this menu are:

- Analyzer Name Field
- Analyzer Type Field
- Unassigned Pods List
- Activity Indicators

The screenshot shows a configuration menu with the following elements:

- Top left: "IM Sample LA C" and "Configuration" buttons.
- Top right: "Print" and "Run" buttons.
- Analyzer 1 section: "Analyzer 1" title, "Name: MACHINE 1" field, and "Type: Timing" dropdown.
- Analyzer 2 section: "Analyzer 2" title, "Name: MACHINE 2" field, and "Type: State" dropdown.
- Unassigned Pods section: A list of pods with their respective activity indicators:
 - C1: ... J
 - C2: ... K
 - B1: ... J
 - B2: ... K
 - B3: ... L
 - B4: ... M
 - C3: ... L
 - C4: ... M

Configuration Menu with Partition, Pods, Names

Analyzer Name Field

The Name field lets you assign a specific name to the analyzer machine. Use the pop-up alphanumeric keypad to enter the name. When you have stored several configurations to disk and later reload them, having assigned a specific name to an analyzer can help identify the measurement setup.

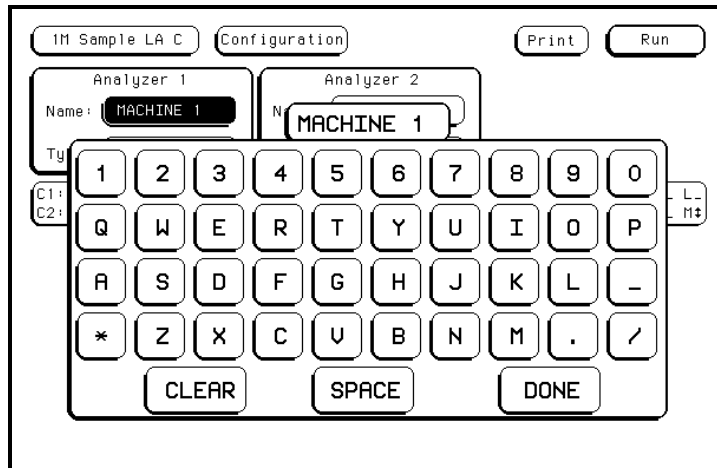

Name Field

Analyzer Type Field

The Type field allows you to configure each analyzer as either a state or timing analyzer. When the Type field is selected, the following choices are available.

- Timing
- State
- State Compare
- SPA

Timing

When you select Timing, the analyzer uses its own internal clock to clock measurement data into the acquisition memory. This clock is asynchronous to the signals in the target system. When this option is selected, some fields specific to external clocks will not appear in the analyzer menus.

You can configure the machine with only one timing analyzer. If you select both analyzers as timing analyzers, the first will be turned off.

State

When you select State, the analyzer uses a clock from the system under test to clock measurement data into acquisition memory. This clock is synchronous with the signals in the target system. You can configure both analyzers as state analyzers. State mode does not allow you to access the Compare menu.

State Compare

When State Compare is selected, the Compare menu is available in the main menu selection. For more details on Compare, see chapter 9, "The Compare Menu." State Compare mode functions much like State mode, except that total memory is reduced by one-fourth.

SPA

SPA stands for System Performance Analysis. It uses an external clock like a state analyzer but measures overall system performance rather than recording discrete activity. For more details, see Chapter 11.

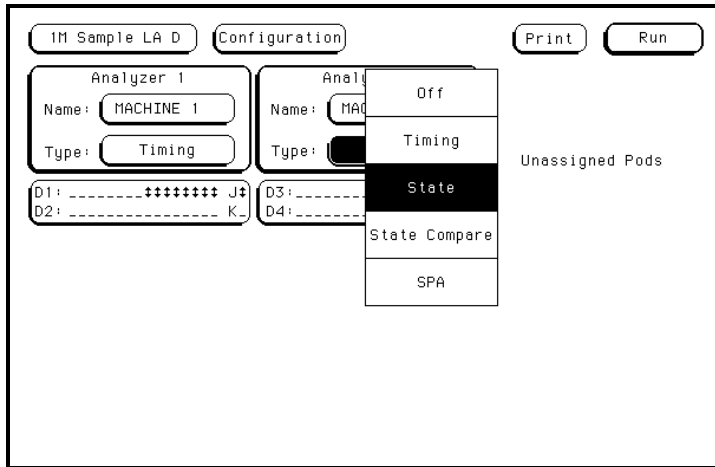

Type Field

Unassigned Pods List

The list of unassigned pods in the Configuration menu shows the available pods for the module configuration. Pod grouping and assignment is by pod pairs. When you want to assign a pod pair to an analyzer, touch the pod field. From the assignment menu, select a destination for the pod pair. Use the same procedure to reassign pod pairs that have previously been assigned to an analyzer.

Because you may have a system with up to five analyzer cards, it is possible to assign more pod pairs to an analyzer than will fit on the display. When that happens, a pod scrolling box appears above the Unassigned Pods list. To view pod pairs assigned to an analyzer that are not visible, touch the pod scrolling box to turn it light blue and use the knob to scroll through the list.

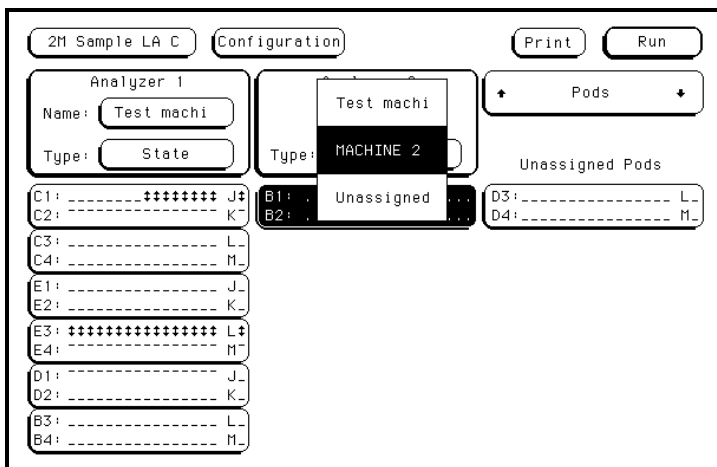

Unassigned Pods Display

When both analyzers are turned on, the pods of the master card cannot be assigned to the same analyzer. If you do assign them to the same analyzer, you'll get an error message when you try to exit the configuration menu. The error message gives an explanation of the problem and provides selection fields with options for reassigning one of the pod pairs.

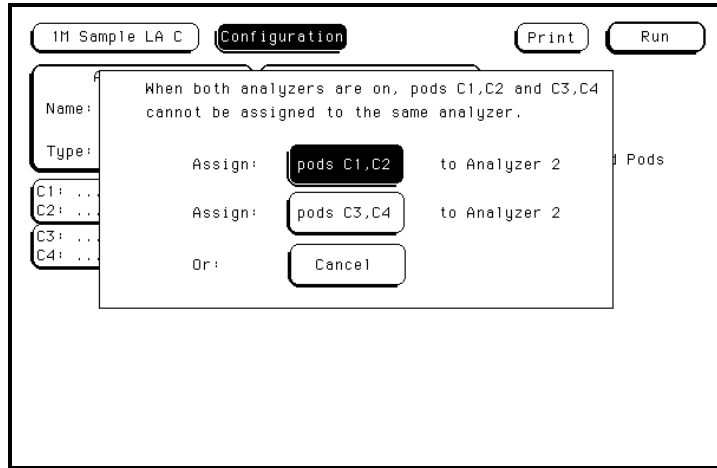

Pod Reassignment Menu

Activity Indicators

Within each pod pair you'll notice activity indicators for each bit of each pod. These indicators appear in two places. One is in the pod pair displays of this Configuration menu. The other place is in the bit reference line in the Format menu just above the pod bit numbers.

When the logic analyzer is properly connected to an active target system, you'll see either a high-level dash, a low-level dash, or a transitional arrow in the Activity Indicator displays for each pod pair. These indicators are very useful in showing proper probe connections and that the logic levels are as expected.

See Also

The "Bit Assignment Fields" in chapter 4, "The Format Menu," for more information on the activity indicators.

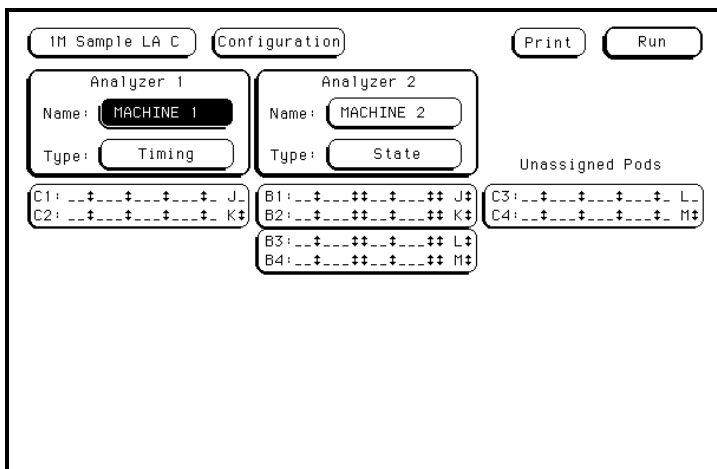

Activity Indicators



The Format Menu

The Format Menu

Use the Format menu to select which data channels are measured and to set up the clocking arrangement to capture valid data. It allows you to group and label the data channels from the system under test to fit your particular measurement. In addition, for your convenience in recognizing bit groupings, you can specify symbols to represent them. If the analyzer is configured as a state analyzer, there are master and slave clocks, clock qualifiers, and a variable clock setup and hold to further qualify what data is captured. In addition, you can set individual pod clock threshold levels. The Format menu contains the following fields:

- State Acquisition Mode Field
- Timing Acquisition Mode Field
- Clock Inputs Display Field
- Pod Field Pod Clock Field
- Master and Slave Clock Field (State only)
- Setup/Hold Field (State only)
- Symbols Field
- Label Assignment Field
- Rolling Labels and Pods Field
- Label Polarity Fields
- Bit Assignment Fields

State Acquisition Mode Field (State only)

The State Acquisition Mode field identifies the channel width and memory depth of the selected acquisition mode.

100 MHz/1M State (HP 16556A)
100 MHz/2M State (HP 16556D)

The State Acquisition Mode uses both pods in a pod pair for 34 channels of width (16 data bits and one clock bit in each pod, and a total memory depth of 1M per channel for an HP 16556A or 2M per channel for an HP 16556D). If time or state tags are turned on, the total memory could be split between data acquisition storage and time or state tag storage. To maintain the full memory per channel depth, leave one pod pair unassigned. State clock speed is 100 MHz.

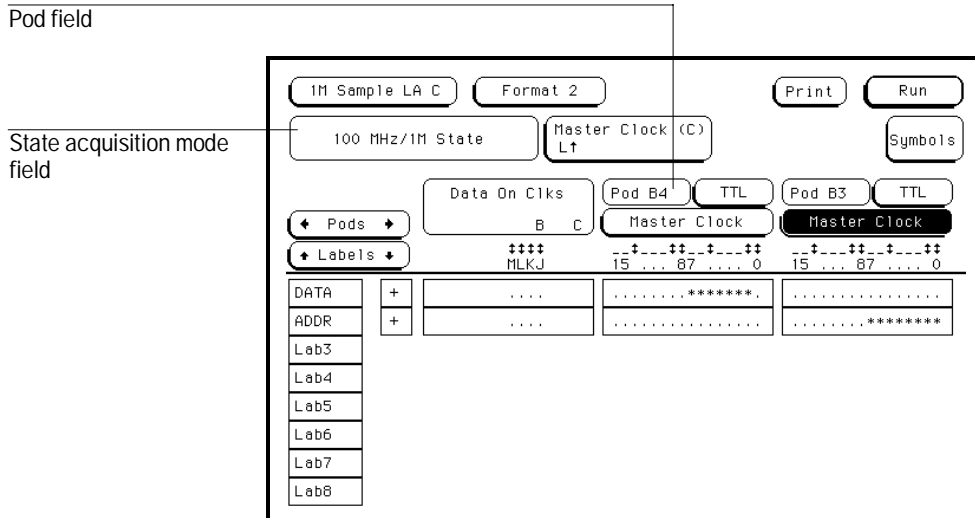
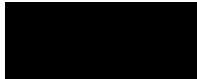

State Acquisition Mode Field

Timing Acquisition Mode Field (Timing only)

The Timing Acquisition Mode field displays the acquisition type, the channel width, and sampling speed of the present acquisition mode. In timing acquisition mode, the analyzer stores measurement data at each sampling interval. Use the Timing Acquisition Mode field to access an acquisition mode selection menu.

Timing Acquisition Mode

The analyzer stores measurement data at each sampling interval.

1M Sample Full Channel 200MHz (HP 16556A)

2M Sample Full Channel 200MHz (HP 16556D)

The total memory depth is 1M (HP 16556A) or 2M (HP 16556D), with data being sampled and stored every 5 ns.

2M Sample Half Channel 400MHz (HP 16556A)

4M Sample Half Channel 400MHz (HP 16556D)

The total memory depth is 2M (HP 16556A) or 4M (HP 16556D), with data being sampled and stored every 2.5 ns.

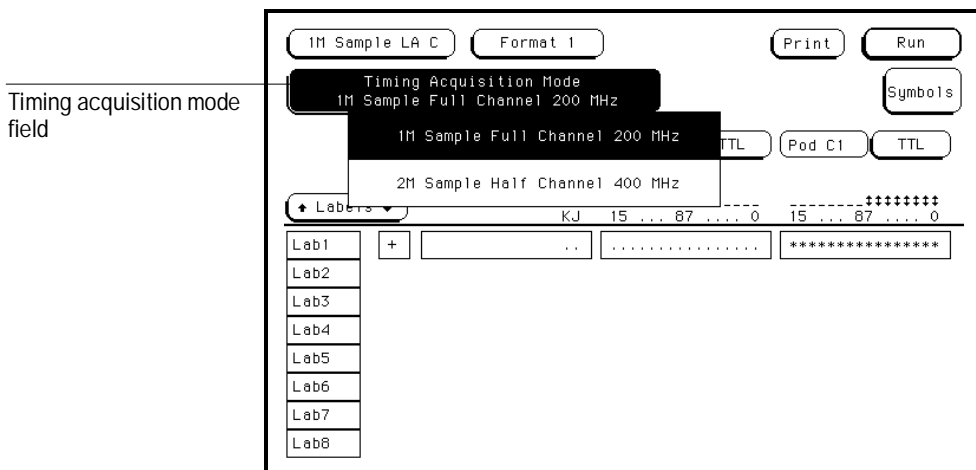

Timing Acquisition Mode Field

Data on Clocks Display

This display shows the clock input channels available for the present configuration. There are four clock input channels (J, K, L, and M) for each card of a module, one for each pod. This display shows only the clock input channels for those pods that are assigned in the present configuration.

A single-card module has four clock input channels, each of which may be used as a state clock (when the machine is configured for state mode) or as a data channel (in either state or timing modes). In a multi-card module, only the four clock input channels connected to the Clock Master card of the module are available for use as state clocks, but all of the clock input channels of the module (there are four for each card in the module) may be used as data channels. A clock input channel, when used as a data channel, is treated as an ordinary data channel, except it cannot be included in a Range resource.

In the display panel, the clock input channels of the Clock Master card are grouped on the right, underneath the slot letter of the Clock Master card, with the clock input channels of the other cards displayed to the left of those of the Clock master card. If any clock input channel is used as a data channel, that bit must be assigned. Activity indicators above the clock identifier show signal activity on that clock input channel.

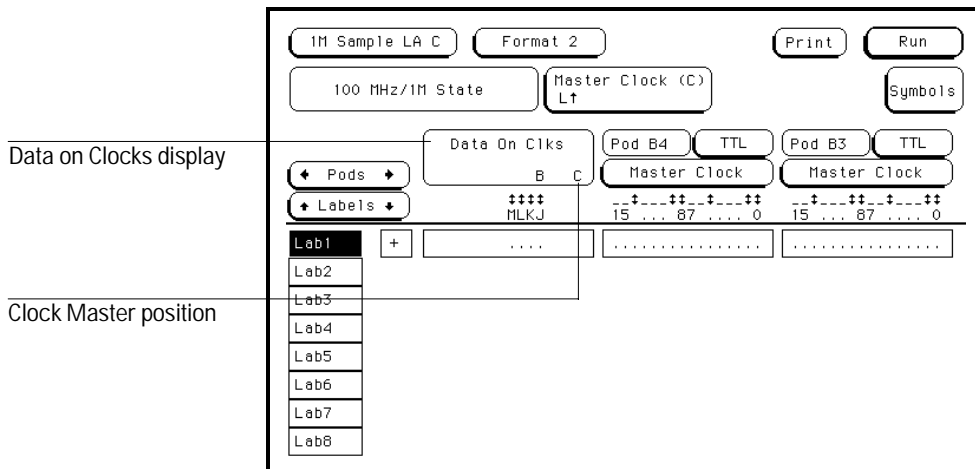

Data on Clocks Display

Pod Field

The Pod field identifies which pod of a pod pair is affected by the settings of the bit assignment field, pod threshold field, and pod clock fields. In the full channel modes, this field is simply an identifier and is not selectable. However, in the half-channel mode, the Pod field turns dark, which means it is selectable. In the half-channel mode, one pod of a pod pair is selectable and all pod settings affect the selected pod.

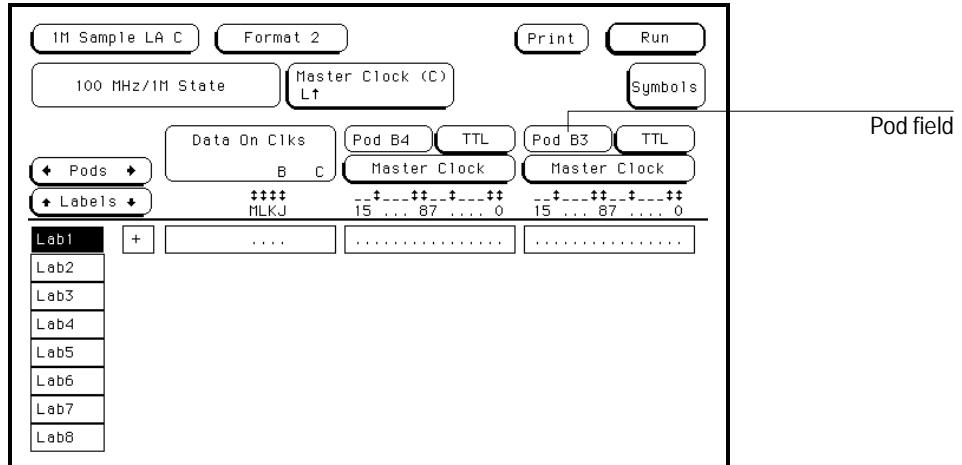

Pod Field

Pod Clock Field (State only)

There is one Pod Clock field for each pod in the machine, and it is used to indicate whether that pod's data lines are to be strobed into memory by the Master clock, Slave clock, or both, in the Demultiplex mode of operation. When the Pod Clock field is selected, a clock menu appears with the following choices:

- Master
- Slave
- Demultiplex

The Master and Slave clock events are specified in the Master and Slave clock fields. These clock functions are available only in a state analyzer.

See Also

The "Master and Slave Clock Field" later in this chapter for information about configuring a clocking arrangement.

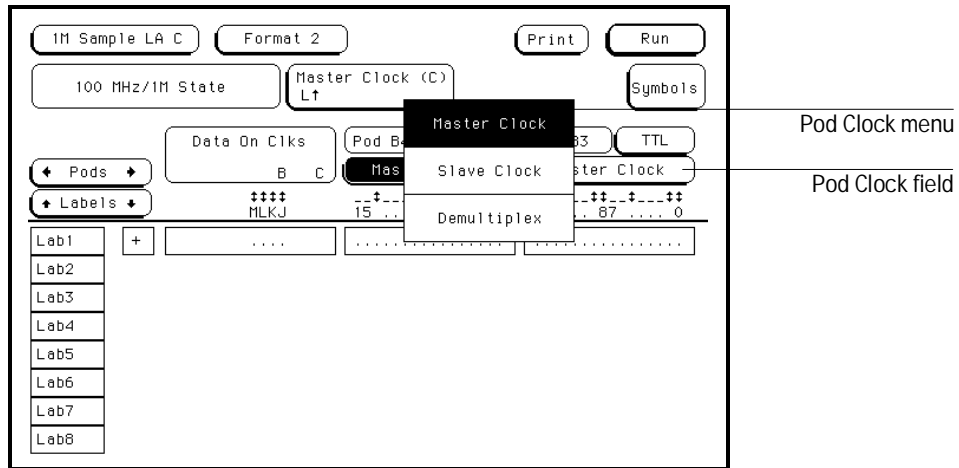

Pod Clock Field

Master

This option specifies that data on all pods designated "Master Clock," in a single analyzer, are strobed into memory when the status of the clock lines matches the clocking arrangement specified under the Master Clock.

Slave

This option specifies that data on a pod designated "Slave Clock" is latched when the status of the state clock inputs meets the requirements of the slave clocking arrangement. Then, followed by a match of the master clock and the master clock arrangement, the slave data is strobed into analyzer memory along with the master data. If multiple slave clocks occur between master clocks, only the data latched by the last slave clock prior to the master clock is strobed into analyzer memory.

Demultiplex

The Demultiplex mode is used to store two different sets of data that occur at different times on the same channels. In Demultiplex mode, only one pod of the pod pair is used, and that pod is selectable. Both the master and slave clocks are used in the Demultiplex mode. Channel assignments are displayed as Demux Master and Demux Slave. For easy recognition of the two sets of data, assign slave and master data to separate labels.

When the analyzer sees a match between the state clock inputs and the slave clock specification, Demux Slave data is latched. Then, followed by a match of the state clocks and the master clock specification, the slave data is strobed into analyzer memory along with the master data. If multiple slave clocks occur between master clocks, only the data latched by the last slave clock prior to the master clock is strobed into analyzer memory.

The screenshot shows the 'Format 2' menu with the following settings:

- 1M Sample LA C
- Format 2
- Print
- Run
- 100 MHz/1M State
- Master Clock (C) Lt
- Slave Clock (C) Lt
- Symbols
- Data On Clks: B C
- Pod B4: Demux Master
- TTL
- Pod B4: Demux Slave
- Labels: M KJ, 15 ... 87 ... 0, 15 ... 87 ... 0
- DATA +
- ADDR +
- Lab3
- Lab4
- Lab5
- Lab6
- Lab7
- Lab8

Demultiplex Cloning Mode

Pod Threshold Field

Use the Pod Threshold field to set a voltage level the data must reach before the analyzer recognizes and displays it as a change in logic levels. You specify a threshold level for each pod. The level specified for each pod is also assigned to the pod's clock threshold. When the Pod Threshold field is touched, a threshold selection pop-up menu appears with the following choices:

TTL

When TTL is selected as the threshold level, the data signals must reach +1.5 volts.

ECL

When ECL is selected as the threshold level, the data signals must reach -1.3 volts.

USER

When USER is selected as the threshold level, the data signals must reach a user selectable value between -6.0 volts to +6.0 volts.

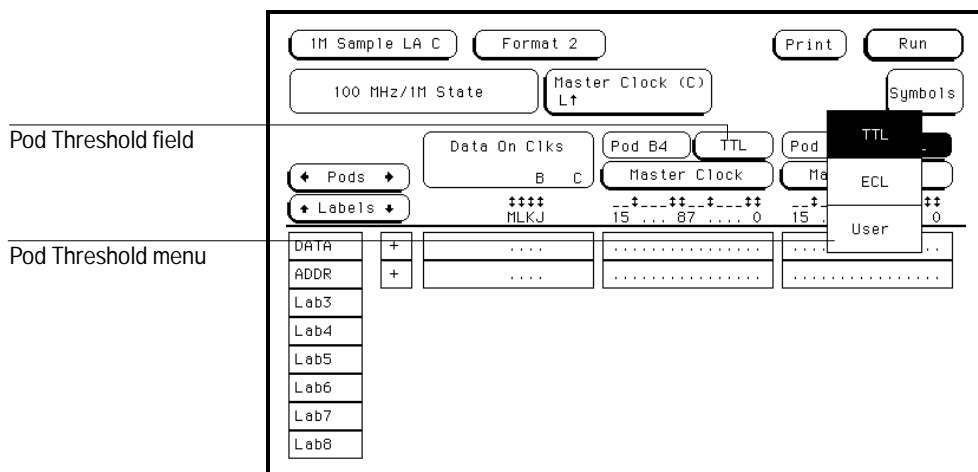

Pod Threshold Field

Master and Slave Clock Field (State only)

The Master and Slave Clock fields are used to construct a clocking arrangement. A clocking arrangement is the assignment of appropriate clocks, clock edges, and clock qualifier levels which allow the analyzer to synchronize itself on valid data.

When the Master or Slave Clock field is selected, a clock/qualifier selection menu appears showing the available clocks and qualifiers for a clocking arrangement. There are four clocks available (J, K, L, M), and four clock qualifiers available (Q1 through Q4).

A single-card module has four clock inputs (one for each pod), and any of these four clocks may be used as state clocks for specifying Master and Slave clocking arrangements. For a multi-card module, only the four clocks of the Clock Master board are available for use as state clocks. Any unassigned clocks may be used as data channels.

See Also

The "Pod Clock Field" earlier in this chapter for information on selecting clocking arrangement types such as Master, Slave, or Demultiplex.

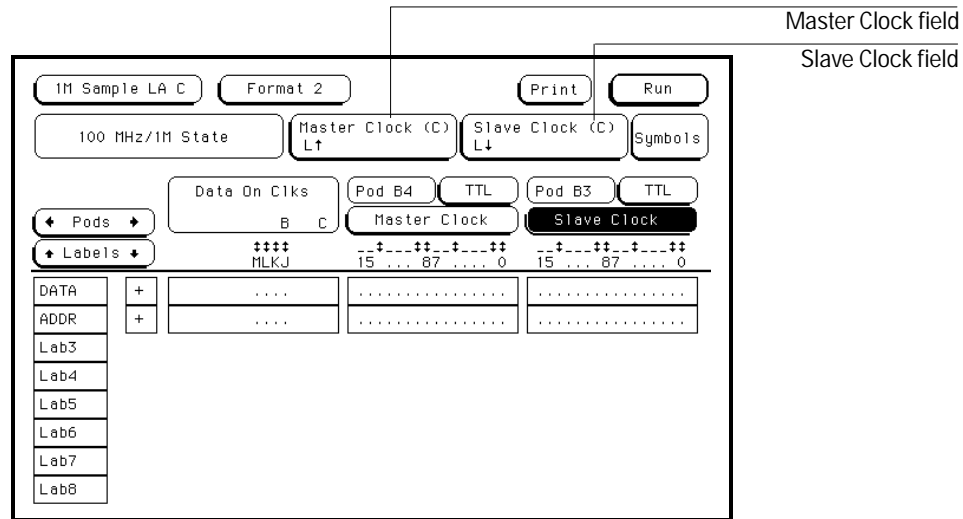

Master Clock Field

Setup/Hold Field (State only)

The Setup/Hold field is reached from the Master Clock or Slave Clock menu. Setup/Hold adjusts the relative position (in time) of the clock edge with respect to the time period that data is valid. When the Setup/Hold field is selected, a configuration menu appears. Use this Setup/Hold configuration menu to select each pod in the analyzer and assign a Setup/Hold selection from the selection list.

With a single clock edge assigned, the choices range from 3.5 ns Setup/0.0 ns Hold to 0.0 ns Setup/3.5 ns Hold. With both edges of a single clock assigned, the choices are from 4.0 ns Setup/0.0 ns Hold to 0.0 ns Setup/4.0 ns Hold. If the analyzer has multiple clock edges assigned, the choices range from 4.5 ns Setup/0.0 ns Hold to 0.0 ns Setup/4.5 ns Hold.

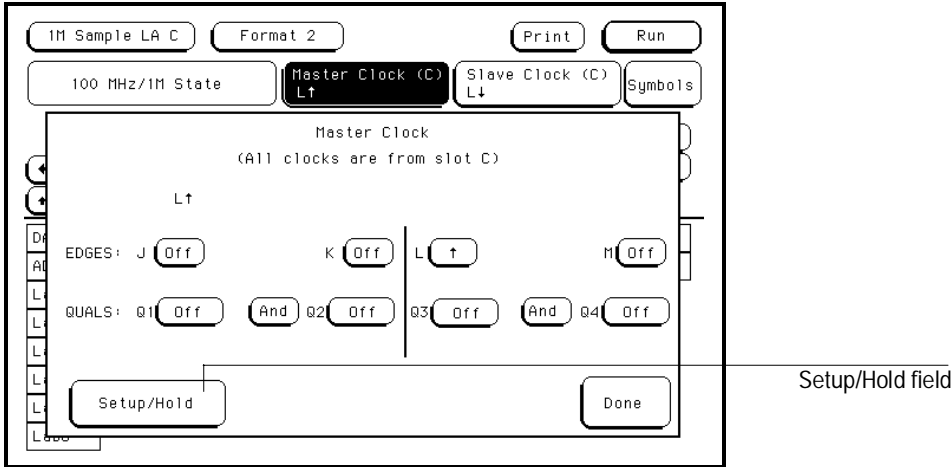

Setup/Hold Field

The Format Menu
Setup/Hold Field (State only)

The relationship of the clock signal and valid data under the default setup and hold is shown.

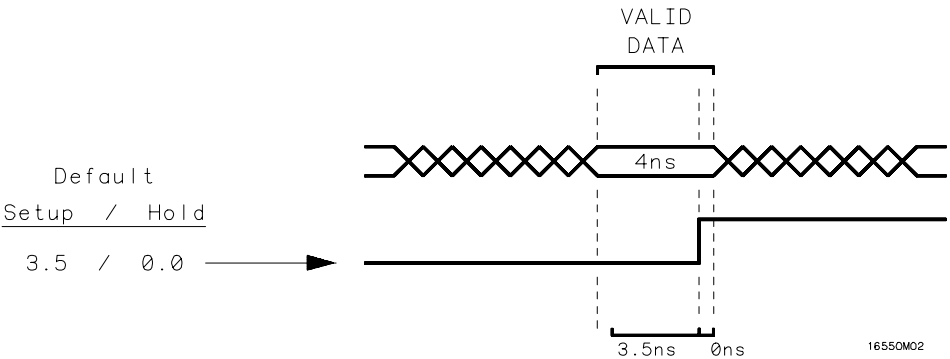

Default Setup and Hold

If the relationship of the clock signal and valid data is such that the data is valid for 1 ns before the clock occurs and 3 ns after the clock occurs, you will want to use the 1.0 setup and 2.5 hold setting.

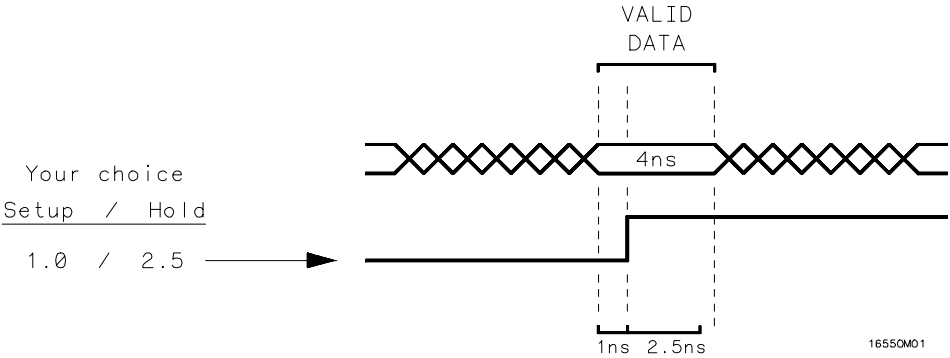

Clock Position in Valid Data

Symbols Field

See Also Symbols Assignment in "Common Module Operations" in the *HP 16500 User's Reference* for complete information on using symbols.

Label Assignment Fields

See Also Labels Assignment in "Common Module Operations" in the *HP 16500 User's Reference* for complete information on using labels.

Rolling Labels and Pods

The rolling function is the same for all items that are stored offscreen.

See Also Labels Assignment in "Common Module Operations" in the *HP 16500 User's Reference* for complete information about rolling labels and pods.

Label Polarity Fields

Use the Label Polarity fields to assign a polarity to each label. The default polarity for all labels is positive (+). Change the label polarity by touching the polarity field. This toggles between positive (+) and negative (-) polarity.

When the polarity is inverted, all data, as well as bit pattern specific configurations used for identifying, triggering, or storing data, reflect the change of polarity. In a timing analyzer with the data inverted, the waveform display does not change.

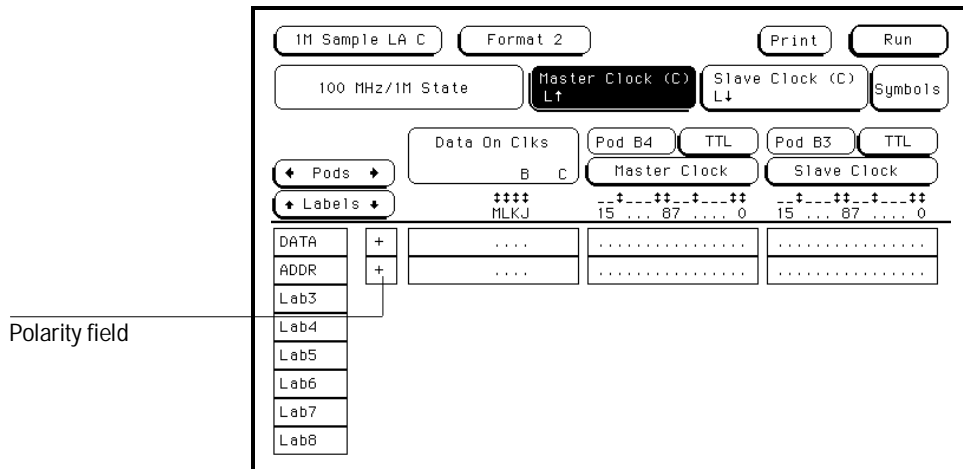

Polarity Field

Bit Assignment Fields

The bit assignment fields are used to assign bits (channels) to labels. The convention for bit assignment is as follows:

- * (asterisk) indicates an assigned bit.
- . (period) indicates an unassigned bit.

To change a bit assignment, select the bit assignment field and, using the knob, move the cursor to the bit you want to change, then select an asterisk or a period. When the bits are assigned as desired and you close the pop-up menu, the screen displays the new bit assignment.

See Also

"Activity Indicators" in chapter 3, "The Configuration Menu," for more information on the bit reference line and the activity indicators on the bit reference line.

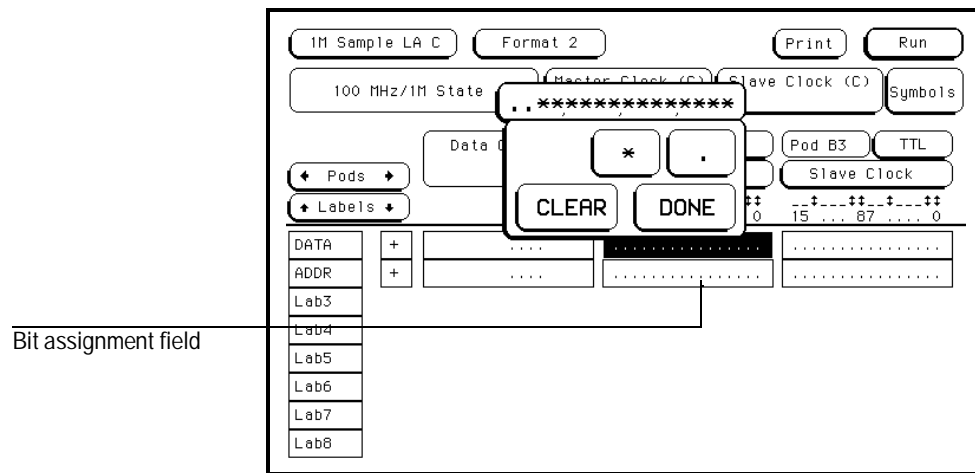

Bit Assignment Field

The Format Menu
Bit Assignment Fields

Labels may have from 1 to 32 channels assigned to them. If you try to assign more than 32 channels to a label, the logic analyzer will beep and a message will appear at the top of the screen telling you that 32 channels per label is the maximum. Channels assigned to a label are numbered from right to left, with the least significant bit on the far right, numbered 0.

Although labels can contain split fields, assigned channels are always numbered consecutively within a label.

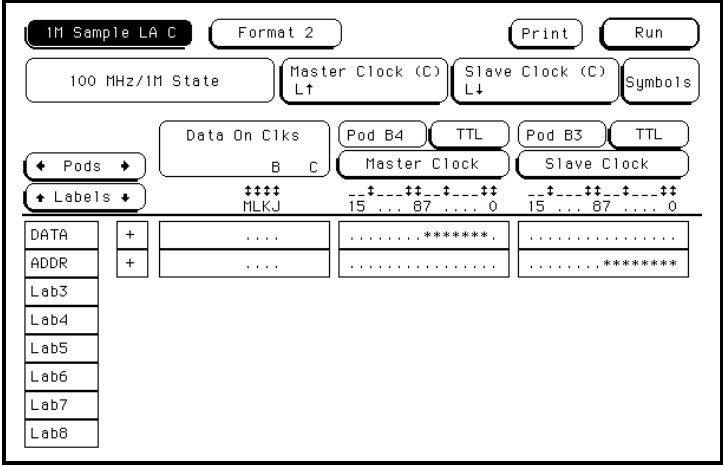

Bit Assignment Example



The Trigger Menu

The Trigger Menu

The Trigger menu is used to specify when the analyzer triggers and what the analyzer stores in acquisition memory. The Trigger menu can be viewed as having four functionally different sections:

- Automatic Sequence Levels, located in the large light blue center box
- Manual Sequence Levels, also located in the large light blue center box
- Resource Terms, located at the bottom of the menu
- Control Fields, located at the right side of the display

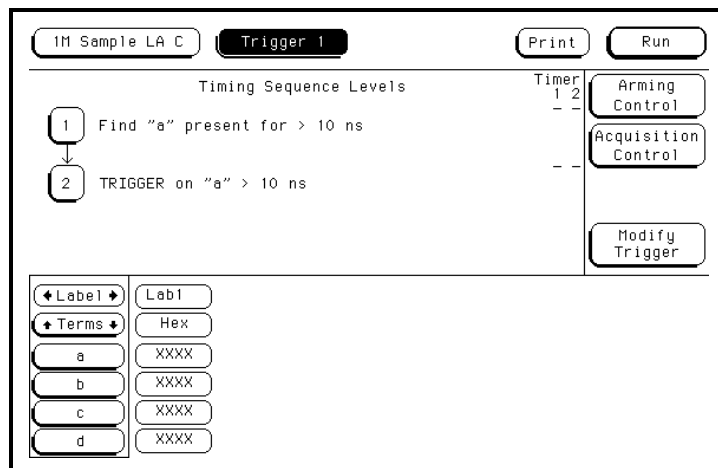

The Trigger Menu

Predefined Trigger Macros

The state and timing acquisition modes each have a macro library containing predefined trigger macros. Each macro will require at least one sequence level, and in some cases, several levels. Macros can be branched to by combining a user-defined level with a macro level. To use these predefined trigger macros, see "Using Macros to Create a Trigger Specification" on the next page. The macro libraries are as follows:

Timing Trigger Macro Library:

- User Mode (user-defined macro)
- Basic Macros
- Pattern/Edge Combination Macros
- Time Violation Macros
- Delay Macros

State Trigger Macro Library:

- User Mode (user-defined macro)
- Basic Macros
- Sequence Dependent Macros
- Time Violation Macros
- Delay Macros

Using Macros to Create a Trigger Specification

1. From the Trigger menu, enter the desired sequence level by selecting the Modify Trigger field or by selecting a sequence level number.

See Also "Editing Sequence Level" and "Modify Trigger Field" for information on accessing levels.

2. From within the sequence level, select the Select New Macro field

3. Scroll to highlight the macro you want, then select the Done field.

4. Select the appropriate assignment fields and insert the desired predefined resource terms, numeric values, and other parameter fields required by the macro. Select the Done field.

See Also "Resource Terms" for information on using predefined resource terms.

Timing Trigger Macro Library

The following list contains the macros in the Timing Trigger Macro Library. They are listed in the order in which they appear on the screen.

User Mode

User level - custom combinations, branching

The User level lets you manually design a sequence level. It uses from one to five internal sequence levels, depending on what you define.

Basic Macros

1. Find anystate n times

This macro becomes true with the nth state it sees. It uses one internal sequence level.

2. Find pattern present/absent for > duration

This macro becomes true when it finds a pattern you have designated that has been present or absent for greater than or equal to the set duration. It uses four or five internal sequence levels.

3. Find pattern present/absent for < duration

This macro becomes true when it finds a pattern you have designated that has been present or absent for less than the set duration. It uses one internal sequence level.

4. Find edge

This macro becomes true when the edge you have designated is seen. It uses one internal sequence level.

5. Find nth occurrence of an edge

This macro becomes true when it finds the occurrence of an edge you have designated. It uses one internal sequence level. The 400-MHz trigger sequencer may not count edges captured closer than 2.5 ns apart.

Pattern/Edge
Combinations

1. Find edge within a valid pattern

This macro becomes true when a selected edge type is seen within the time window defined by a pattern you have designated. It uses one internal sequence level.

2. Find pattern occurring too soon after edge

This macro becomes true when a pattern you have designated is seen occurring within a set duration after a selected edge type is seen. It uses three or four internal sequence levels.

3. Find pattern occurring too late after edge

This macro becomes true when one edge type you have selected occurs and, for a designated period after that first edge is seen, a pattern is not seen. It uses two internal sequence levels.

Time Violations

1. Find 2 edges too close together

This macro becomes true when a second selected edge is seen occurring within a period you have designated after the occurrence of a first selected edge. It uses three or four internal sequence levels.

2. Find 2 edges too far apart

This macro becomes true when a second selected edge occurs beyond a period you have designated after the first selected edge. It uses two internal sequence levels.

3. Find width violations on a pattern/pulse

This macro becomes true when the width of a pattern violates minimum and maximum width settings you have designated. It uses four or five internal sequence levels.

Delay

1. Wait t sec

This macro becomes true after a period you have designated has expired. It uses one internal sequence level.

State Trigger Macro Library

The following list contains the macros in the State Trigger Macro Library. They are listed in the order in which they appear on the screen.

User Mode

User Level - custom combinations, loops

The User level lets you manually design a sequence level. It uses one internal sequence level.

Basic Macros

1. Find anystate n times

This macro becomes true with the nth state it sees. It uses one internal sequence level.

2. Find event n times

This macro becomes true when it sees an event you have specified occurring a designated number of times. The events may occur consecutively, but does not have to. It uses one internal sequence level.

3. Find event n consecutive times

This macro becomes true when it sees an event you have specified occurring a designated number of consecutive times. It uses one internal sequence level.

4. Find event2 immediately after event1

This macro becomes true when the first event you have specified is seen immediately followed by a second designated event. It uses two internal sequence levels.

Sequence
Dependent Macros

1. Find event2 n times after event1, before event3 occurs

This macro becomes true when it first finds a designated event1, followed by a selected number of occurrences of a designated event2. In addition, if a designated event3 is seen anytime while the sequence is not yet true, the sequence starts over. If event2's nth occurrence is coincident with event3, the sequence starts over. It uses two internal sequence levels.

2. Find too few states between event1 and event2

This macro becomes true when a designated event1 is seen, followed by a designated event2, and with less than a selected number of states occurring between the two events. It uses three or four internal sequence levels.

3. Find too many states between event1 and event2

This macro becomes true when a designated event1 is seen, followed by more than a selected number of states, before a designated event2. It uses two internal sequence levels.

4. Find n-bit serial pattern

This macro becomes true when a specified serial pattern of n bits is found. It uses n internal sequence levels.

Time Violations

1. Find event2 occurring too soon after event1

This macro becomes true when a designated event1 is seen, followed by a designated event2, and with less than a selected period occurring between the two events. It uses two internal sequence levels.

2. Find event2 occurring too late after event1

This macro becomes true when a designated event1 is seen, followed by at least a selected period, before a designated event2 occurs. It uses two internal sequence levels.

Delay

1. Wait n external clock states

This macro becomes true after a number of user clock states you have designated has occurred. It uses one internal sequence level.

Sequence Levels

The Sequence Levels section controls when the analyzer triggers, what the analyzer triggers on, and what data is stored in memory before and after triggering occurs. By using sequence levels, you create a sequence of instructions for the analyzer to follow. The instructions contain user-defined resource terms representing such things as timers, ranges, edges, and bit patterns.

As the resource terms are evaluated and acted upon by the analyzer, all subsequent branching and storing within the sequence flow is directed by your instructions. The path taken resembles a flow chart, and the end result is the storage of only the data you need.

The state analyzer has 12 sequence levels available and the timing analyzer has 10 sequence levels available.

Sequence Level Number Field

The Sequence Level Number field identifies an instruction to be evaluated by the analyzer. In addition, you can use the number field to access the Sequence Instruction menu, which allows you to define the automated trigger macros and to manually construct sequence instructions.

The sequence instruction for each level is displayed in text and located just to the right of the level number. The timer status in each level is also displayed to the right of the instruction text.

Sequence Level Roll Field

The Sequence Level Roll field rolls offscreen sequence levels back onscreen. When the Sequence Level field is light blue, use the knob. If the field is dark blue, select it and then use the knob.

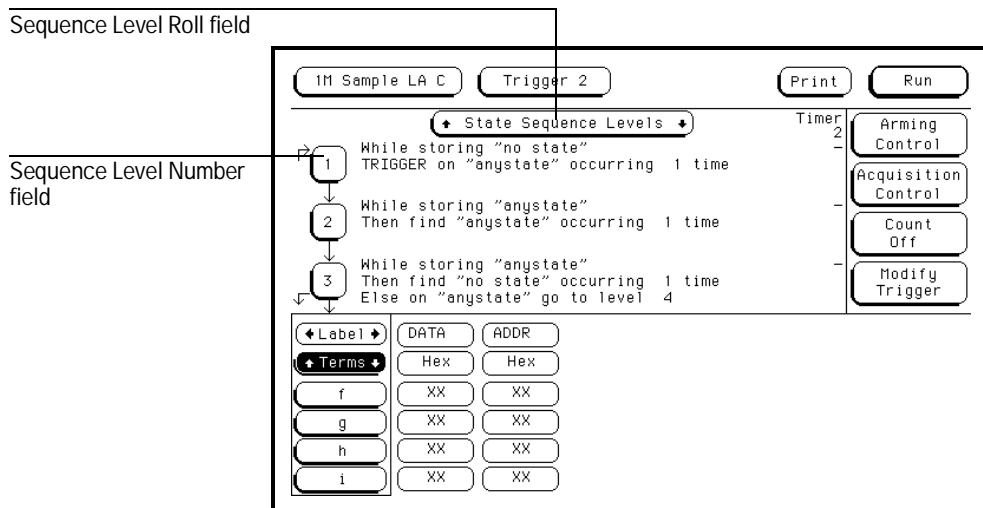

Sequence Level Number field and Sequence Level Roll field

Sequence Instruction Menu

When a Sequence Level Number field is selected, a Sequence Instruction menu appears. Use this menu to create instructions for the Sequence Level Number, to insert adjacent sequence levels, select a new macro, or to delete the current level. The instruction you create will read like a sentence, with the assigned resource terms directing how the analyzer qualifies and stores the desired data. This Sequence Instruction Menu contains the following fields to help you set up trigger conditions:

- Insert Level and Delete Level fields
- Select New Macro field
- Term assignment fields
- Occurrence counter fields
- Branching fields
- Duration counter field (Timing only)
- Timer Control field

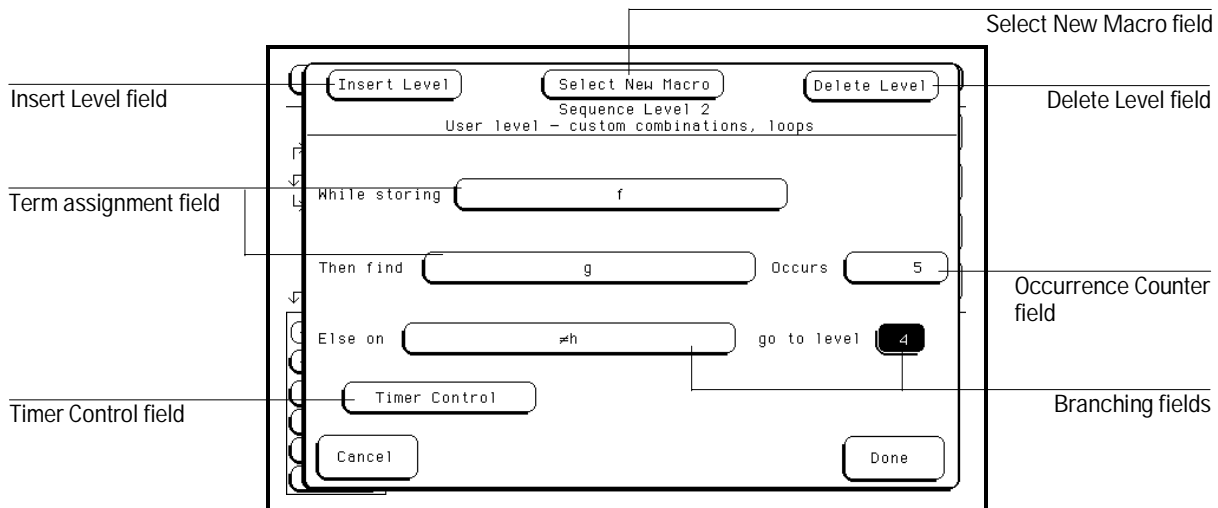

Sequence Instruction menu

Insert Level and Delete Level Fields

The Insert Level field is used to add another sequence level. When this field is selected, depending on the analyzer configuration, you are given choices to add a field before or after the current sequence level. A message appears letting you know when all available sequence levels are inserted. The Delete Level field deletes the selected sequence level.

Select New Macro Field

The Select New Macro field brings up a list of complex triggers that have been built in. There are separate libraries of predefined trigger macros for State and Timing acquisition.

See Also

"Predefined Trigger Macros" in this chapter for more information on predefined trigger macros.

Term Assignment Fields

The Term Assignment fields hold user-defined bit patterns, ranges, timers, and logical combination resource terms. You can logically combine different resource terms to form the kind of instruction needed to qualify the trigger and store operations.

See Also

"Resource Term Fields" later in this chapter for information on assigning a value to the resource terms used by the Term Assignment fields.

Occurrence Counter Field

The Occurrence Counter field indicates the number of times the analyzer must see the resource term before it is allowed to advance to the next sequence level. To assign an occurrence number, simply turn the knob, or select the Occurrence Counter field and use the keypad that appears. The maximum number of occurrences is 1048575. If the "Else on" term is seen before all specified occurrences have taken place, the flow of the sequence instruction goes to the sequence level designated in the Branching field.

See Also

For information on selecting resource term choices and how to assign a value to a resource term, refer to the term types, such as Bit Pattern, Range, or Timers in this chapter.

Branching Field

Each sequence level has two-way branching. If the first resource term is found, the branch is to the next sequence level. If the first resource term is not found, the analyzer evaluates the "Else on" secondary branching term.

If the "Else on" term is found, the secondary branch is taken to the designated sequence level in the Branching field. If the "Else on" term is not found, the analyzer continues to loop within the sequence level until one of the two branches is found. If the "Else on" branch is taken, the occurrence counter is reset even if the "go to level" branch is to the same level.

If both terms are found at the same time, the branch is to the next sequence level after the required number of first term occurrences.

Branching across trigger levels is possible. If this occurs, the sequence level evaluation could loop without ever seeing a trigger term. Take care in designing your flowchart and constructing the sequence instructions to avoid this possibility.

To set a sequence level branch, select the second Branching field, then select a destination sequence level number.



Duration Counter Field (Timing only)

The Duration Counter field displays a user-definable period for which the resource term must be valid.

> Field When the greater-than sign (>) precedes the Duration Counter field, the analyzer continues sequence level evaluation only after the resource term has been true for a period greater than or equal to the duration specified.

< Field When the less-than sign (<) precedes the Duration Counter field, the analyzer continues sequence level evaluation only after the resource term has been true for a period less than or equal to the duration specified. Each less-than assignment (<) uses three sequence levels.

When < or > duration is assigned, the secondary branching (Else on) is not available. To assign a duration, simply turn the knob, or select the Duration Counter field and use the keypad that appears.

Occurs Field When "Occurs" is selected, the Duration Counter field changes to an occurrence counter, and the sequence evaluation is delayed until the resource term has occurred the number of times selected. To assign an occurrence value, turn the knob or select the occurrence field and use the keypad that appears. The maximum number of occurrences is 1048575.

When the "Occurs" selection is made, the "Else on" resource term (secondary branch) becomes available for a second branching option. If the first resource term (primary branch) is not found, and the second resource term is found, the analyzer branches to the sequence level designated in the Branching field.

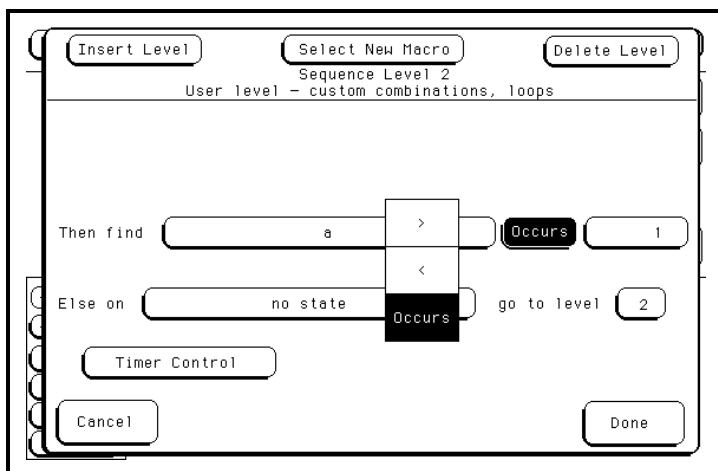

Sequence Level Instruction

Timer Control Field

The Timer Control field is used to access the Timer Control menu. Use the Timer Control menu to Start, Stop, Pause, or Continue timer operation as the analyzer enters a sequence level. You can control the same timer from each sequence level. The default timer condition in all sequence levels is Off.

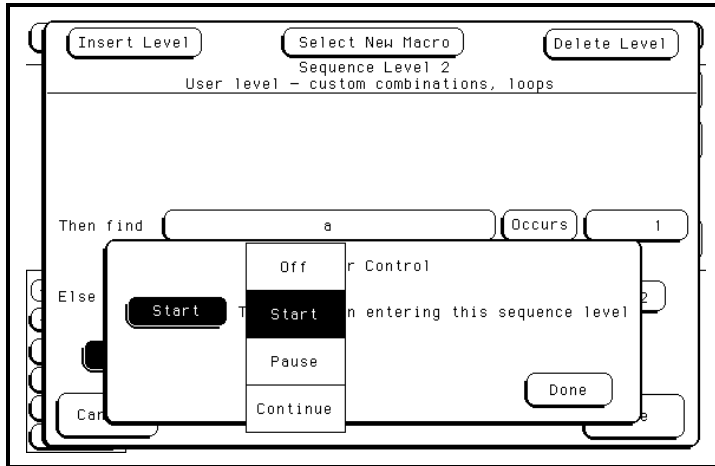

Timer Control Menu

Resource Terms

Resource terms are the user-defined variables that you can place in the Term Assignment fields of the sequence instructions. Resource terms can take the form of bit patterns, ranges, timers, or edge terms. They are used separately or in logical combinations with other terms. The analyzer evaluates the sequence instruction and resource terms and determines if the instruction is true or false. Depending on a true or false evaluation, the appropriate branching direction occurs. The terms and fields are:

- Resource Term Fields
- Bit Pattern Terms
- Range Terms
- Timer Terms
- Edge Terms (Timing only)
- Combination of Terms

The screenshot shows a software interface for configuring a state sequence. At the top, there are buttons for "1M Sample LA C", "Trigger 2", "Print", and "Run". Below these is a "State Sequence Levels" section with a dropdown arrow. The sequence consists of three levels:

- Level 1: While storing "f", TRIGGER on "h" occurring 5 times, Else on "in_range2" go to level 2
- Level 2: While storing "f", Then find "g" occurring 5 times, Else on "wh" go to level 4
- Level 3: While storing "anystate", Then find "no state" occurring 1 time, Else on "anystate" go to level 4

To the right of the sequence is a "Timer" section with a dropdown set to "2" and buttons for "Arming Control", "Acquisition Control", "Count Off", and "Modify Trigger". Below the sequence is a "Resource Term Fields" section with a "Label" dropdown and a "Terms" dropdown. The "Terms" dropdown is expanded, showing a table of terms:

Label	DATA	ADDR
f	XX	XX
g	XX	XX
h	XX	XX
i	XX	XX

A line from the text "Resource term fields" points to the "Terms" dropdown in the interface.

Resource Term Fields

Resource Term Fields

The Resource Term fields identify the terms available for use within the analyzer. The Resource Term fields are also used to access the Resource Term Configuration menu.

Just to the right of the Resource Term fields are the corresponding assignment fields which display the assigned values and are also used to access an assignment keypad.

Resource Terms Roll Field

Offscreen resource terms are rolled back onscreen by using the knob when the Terms field is light blue. If the Terms field is dark blue, it must be selected, which then turns it light blue.

The screenshot displays the 'Trigger 2' configuration screen. At the top, there are buttons for 'IM Sample LA C', 'Trigger 2', 'Print', and 'Run'. Below these is a 'State Sequence Levels' section with a dropdown arrow. The sequence consists of three levels:

- Level 1:** While storing "f", TRIGGER on "h" occurring 5 times, Else on "in_range2" go to level 2.
- Level 2:** While storing "f", Then find "g" occurring 5 times, Else on "wh" go to level 4.
- Level 3:** While storing "anystate", Then find "no state" occurring 1 time, Else on "anystate" go to level 4.

To the right of the sequence is a 'Timer' field set to '2' and a vertical 'S' indicator. Further right are control buttons: 'Arming Control', 'Acquisition Control', 'Count Off', and 'Modify Trigger'. At the bottom, there is a 'Label' dropdown and a 'Terms' dropdown. Below these are two columns of fields: 'DATA' and 'ADDR'. The 'DATA' column contains 'Hex', 'f', 'g', 'h', and 'i'. The 'ADDR' column contains 'Hex', 'XX', 'XX', 'XX', and 'XX'.

Resource Term Fields

Resource Term Configuration Menu

When any of the Resource Term fields are selected, a Resource Terms Configuration menu appears. Use this configuration menu to assign a resource term to an analyzer, set the resource term to a value, or customize the name of a resource term. The following functions can also be accomplished by selecting the assignment field and using the pop-up keypad.

Clear (=X) Sets the Term Assignment fields as follows:

In Terms a – j, the assignment field is set to all Xs (don't cares).

In Range 1 and 2 terms, the two assignment fields are set to maximum (Fs) and minimum (0s) settings.

In Timer 1 and 2 terms, the assignment field is reset to a minimum time of 400 ns.

In Edge 1 and 2 terms, the assignment field is reset to a period (.).

Set (=1) Sets the Term Assignment fields as follows:

In Terms a – j, the assignment field is set to all 1s (highs).

This option is not available for the two Range, Timer, and Edge terms.

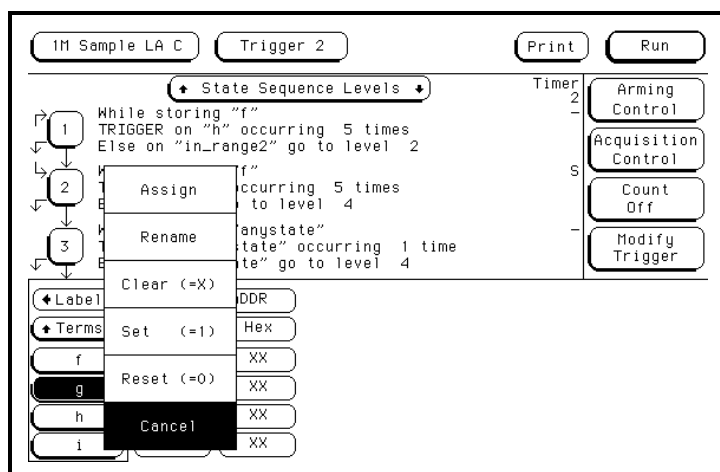

Resource Term Configuration Menu

Reset (=0) Sets the assignment fields as follows:

In Terms a – j, the assignment field is set to all 0s (lows). This option is not available for the two Range, Timer, and Edge terms.

Rename This function accesses a keypad that you use to create a custom name for the resource term. This function works for all resource terms.

Assign All of the available resource terms except Edge terms can be assigned to either analyzer. The Edge terms are only used in a timing analyzer. A term, however, can be assigned to only one analyzer at a time. When a resource term is selected, it toggles between analyzers.

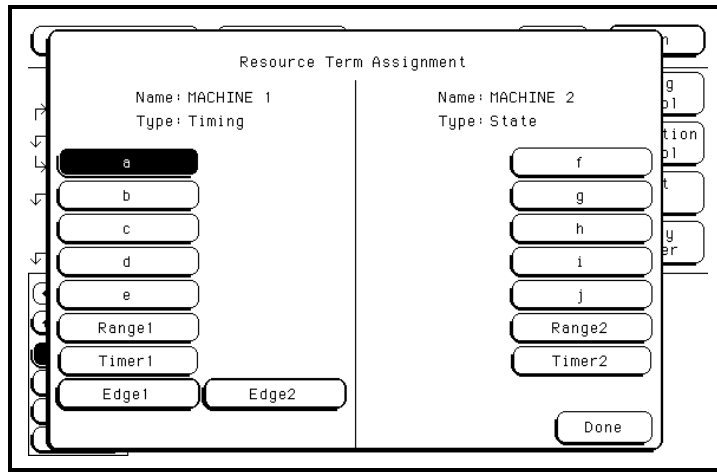

Resource Term Assignment Menu

Bit Pattern Terms

Bit Pattern terms are set to match the numeric value or bit pattern of a group of data channels. The ten available Bit Pattern terms are "a" through "j." Each term can be assigned to either of the two analyzers, but not both. The complement of the bit patterns you specify for "a" through "j" are available by selecting "≠a" through "≠j."

Bit Pattern Assignment

The assignment of a bit pattern to the resource terms "a" through "j" can be done in two ways. If you want a pattern of all 1s, all 0s, or all Xs (don't cares), you can insert these values by selecting the resource term field itself, then select your choice from the Resource Term Configuration menu.

If you want some other pattern, use the pop-up keypad to assign the bit pattern. The keypad becomes available when you select the assignment field for each term.

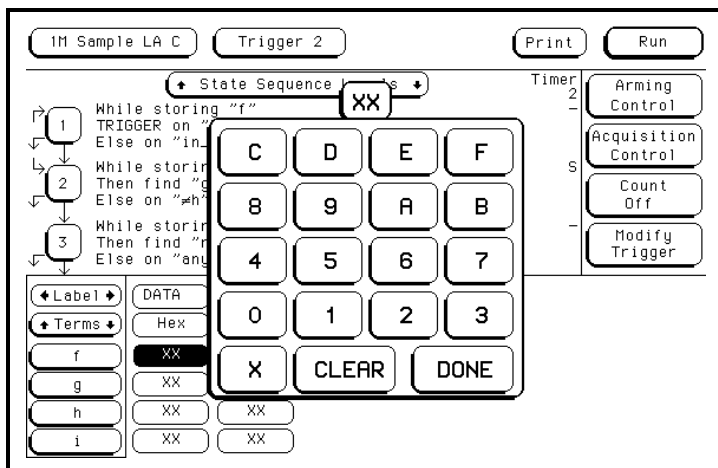

Bit Pattern Resource Term

Bit Pattern Selection

After the resource terms have values assigned, they are inserted into the sequence instruction where they direct the flow of that sequence instruction. Insert Bit Pattern terms into a sequence instruction by selecting the Term Assignment field, then selecting a term "a" through "j" from the pop-up selection list.

Term	Assignment	Description
anystate	≠g	Level 2 combinations, loops
no state	≠h	
f	≠i	
g	≠j	Occurs 5
h	In range2	go to level 4
i	Out range2	
j	timer2>400ns	
≠f	Combination	

Bit Pattern Term Selection

Range Terms

Range terms bracket groups of bit patterns. There are two available Range terms. Each Range term is assigned to either of the two analyzers, but not both.

When you assign an upper and lower bit pattern boundary, the range is recognized when the data is numerically between or on the two specified boundaries. In addition, the range must be contained in a single pod pair, with no clock bits allowed.

Range Assignment

To assign bit patterns to the upper and lower boundaries of a Range term, you use a pop-up keypad. The keypad appears when you select the upper or lower Range term assignment fields.

You can clear the range boundaries by setting them to all Xs (don't cares) by selecting the Range term field and selecting the Clear (=X) field from the Resource Term Configuration menu. The Clear (=X) option places zeros and Fs in the lower and upper boundaries respectively.

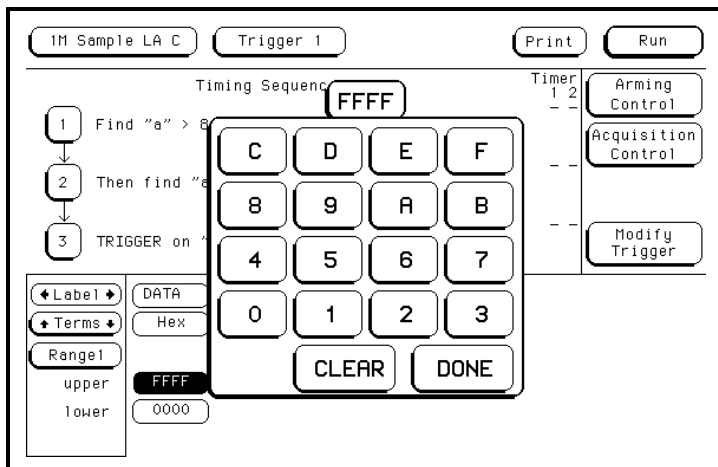

Range Term

Range Term Selection

With upper and lower range boundaries assigned, insert the appropriate In range or Out range terms into the sequence instruction. The In range term is true when the analyzer recognizes a bit pattern on or between the assigned range boundaries. The Out range term is true when the In range term is false. In and Out range terms are inserted into a sequence instruction by selecting the Term Assignment field, then selecting an "In range 1, 2" or "Out range 1, 2" term from the pop-up selection list.

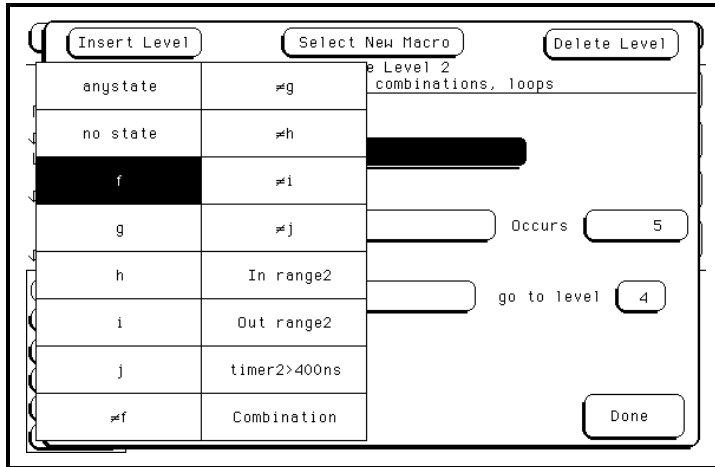

Range Term Selection

Timer Terms

There are two available Timer terms, each of which may be assigned to either of the two analyzers, but not both. Timers can be used as either the trigger term, the store term, or a branching term, within a sequence level. With timers inserted into sequence levels, you can start a timer in one level, pause it, or stop it in another sequence level.

As with other resource terms, timers are either true or false. Timers start as you enter the sequence level, and when its count expires, it becomes true. If a timer is paused in one level, it must be continued in another level before it can count through and become true. Timers can also be inverted, so a timer can start as true and become false when its count expires.

Timer Assignment

To assign a time value to the Timer 1, 2 terms, you use a pop-up keypad which appears when you select the assignment field.

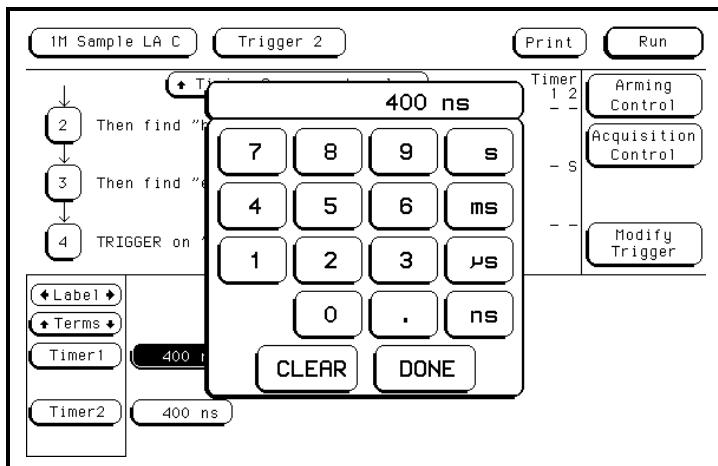

Timer Term Assignment

The minimum value a timer can have is 400 ns, and that is the default value. As more sequence levels are added, the timer status in the new levels defaults to Off. Timers must be continued or started in each new level as is appropriate. When a timer expires or stops, its count resets to zero.

Timer Term Selection

Timer terms are inserted into a sequence instruction by selecting the Term Assignment field, then selecting a "Timer 1, 2" term from the pop-up selection list.

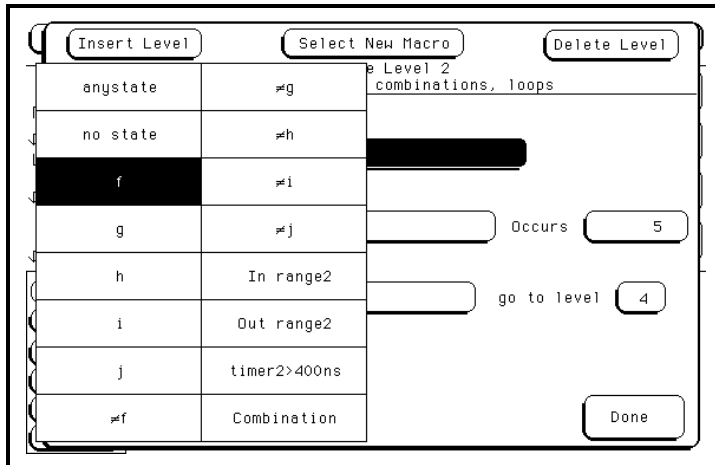

Timer Term Selection

Edge Terms (Timing only)

Edges and glitches can be used to qualify a trigger, store, or branch operation within a sequence instruction. They can be used singularly or in combination with each other across all assigned channels. When you specify an edge or glitch on more than one channel, the analyzer ORs the edges and glitches. If you want to qualify a glitch, place an asterisk (*) on the data channel you are watching. If you want to qualify an edge, place the appropriate edge on the data channel you are watching. The following edge choices are available:

Positive edge (↑)

Negative edge (↓)

Either positive or negative (↕)

No edge (.)

Edge Assignment

After you select the edge assignment field, an assignment menu appears. Use the knob to position the cursor over the bit you want to qualify, then select the glitch or edge choice.

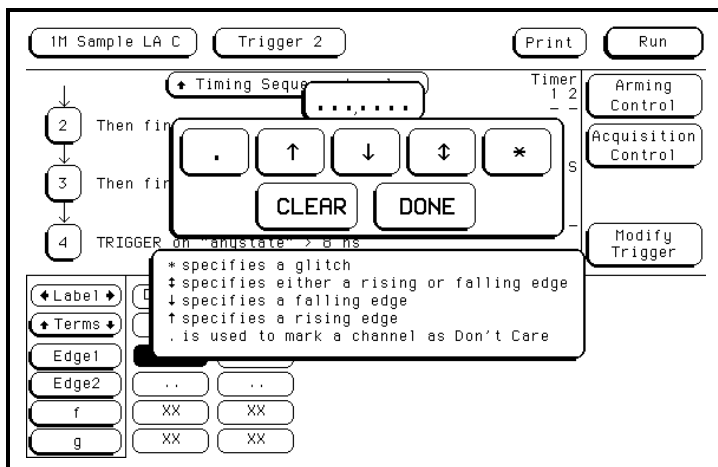

Edge Term

When you finish assigning edges and glitches, select Done. After the assignment menu closes, you will see "\$" or "*" or both indicators in the assignment field display. These symbols signify an assigned edge (\$) or glitch (*) qualifier. When Binary is selected for the numeric base, you see the actual edge and glitch assignments.

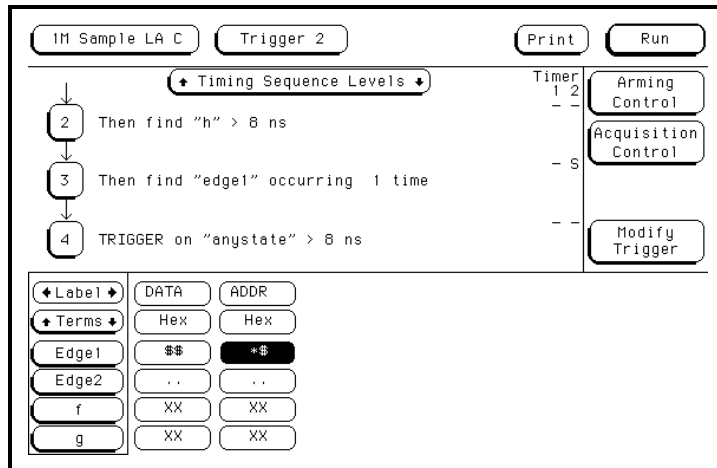

Edge and Glitch Identifiers

Combination of Terms

The Combination selection in the pop-up selection list allows you to create a resource term with a value that is the result of a combination process. The combination process uses the logical AND, NAND, OR, NOR, and XOR functions to combine predefined resource terms. All resource terms that have been assigned to the analyzer are available to influence the value of the combination resource term.

A combination of terms is used as either a trigger term, a store term, or a branching term within a sequence instruction.

Combination Assignment

To assign a combination of terms, first select "Combination" from the pop-up selection list, and then configure the process that creates the value for the combination.

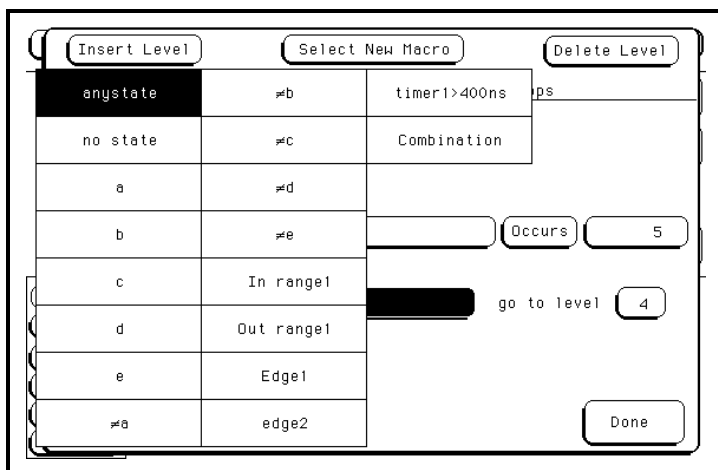

Combination of Terms

Combination Creation

Before a combination of terms is created and inserted into a sequence instruction, the combination process must be configured. When the Term Assignment field is selected, and "Combination" is selected from the pop-up selection list, a Logical Assignment menu appears. Use this menu to select predefined resource terms as inputs to a chain of logical operators.

Configure resource terms into the chain by selecting the desired term, then selecting to either include it (ON), turn it off, or include it in a complemented form (NEGATE).

Configure logical operators into the chain by selecting the Logical Operation field, and then selecting the desired operation from a selection list.

When the configuration process is complete, and the "Done" field is selected, the created Combination of terms is inserted into the Term Assignment field in the sequence instruction.

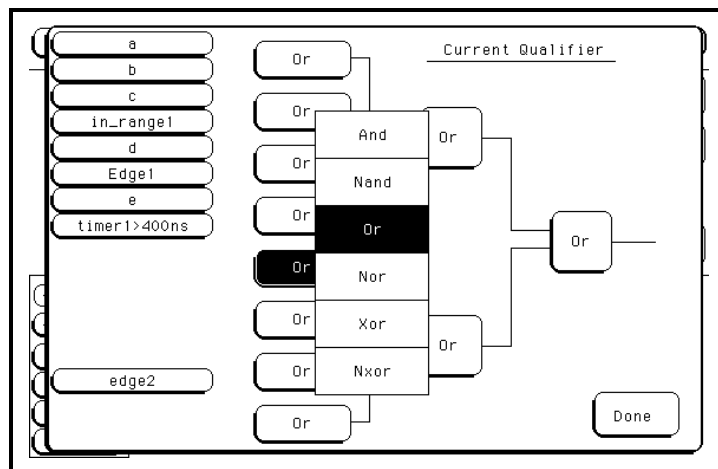

Logical Assignment Menu

Control Fields

The Control fields are located to the right of the large light blue Sequence Levels box. The four control fields are:

- Arming Control Field
- Count Field (State and State Compare only)
- Acquisition Control Field
- Modify Trigger Field

Arming Control Field

The Arming Control field accesses an Arming Control menu which is used to configure the arm signals between analyzers and the Arm In/Out signals between other measurement modules in the mainframe. The arming signals influence the order in which the analyzers and other measurement modules trigger in cross-domain measurements. The three types of arming control are:

- Arming Control Between Analyzers
- Arming Control Between Modules
- ORed Trigger

The screenshot displays the 'Arming Control Field' interface. At the top, it shows 'IM Sample LA C' and 'Trigger 2' with 'Print' and 'Run' buttons. Below this is a 'State Sequence Levels' section with a dropdown menu. The sequence consists of three levels:

- Level 2:** While storing "f", Then find "g" occurring 5 times, Else on "h" go to level 4.
- Level 3:** While storing "anystate", Then find "no state" occurring 1 time, Else on "anystate" go to level 4.
- Level 4:** While storing "anystate", Then find "anystate" occurring 1 time.

To the right of the levels is a 'Timer' section with a '2' and 'S' indicator, and four control buttons: 'Arming Control', 'Acquisition Control', 'Count Off', and 'Modify Trigger'. Below the levels is a table for defining terms:

Label	DATA	ADDR
Terms	Hex	Hex
f	XX	XX
g	XX	XX
h	XX	XX
i	XX	XX

Arming Control Field

Arming Control Between Analyzers

If both analyzers in a module are turned on, you can configure one analyzer to arm the other. For example, when a state analyzer triggers on a bit pattern, it could arm a timing analyzer which then captures and displays the waveform after it triggers. As you configure the Arming Control menu, a graphical representation of the analyzer arming configuration is displayed.

When you select the analyzer name field in the Arming Control menu, a pop-up menu appears that you use to select where the Arm In signal comes from. In addition, a sequence level number field appears which you use to select the sequence level in which an "arm" flag is placed.

When an analyzer receives an Arm-In signal, an "arm" term is placed in a user-selected sequence level and the analyzer automatically begins evaluating its trigger sequence instruction. If in the sequence evaluation, the "arm" term is seen first, the analyzer will trigger. However, if the "arm" term is placed down in the sequence level order, the preceding sequencing could trigger the analyzer before the "arm" term is seen. Generally, the "arm" term is evaluated and used in the same way as the other resource terms within the sequence instruction.

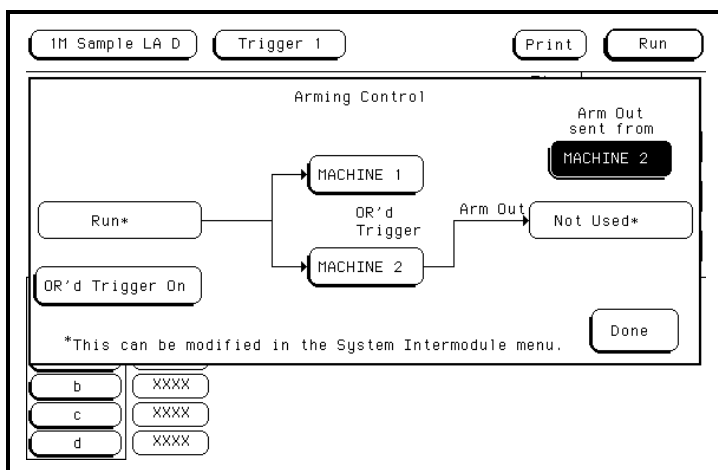

Two Analyzer Arming

Arming Control Between Modules

A more complex arming example involves arming between modules in the mainframe. Intermodule arming requires using the Intermodule menu to configure all the modules involved. As you configure the Arming Control menu, a graphical representation of the analyzer arming configuration is displayed.

The first analyzer is armed by an Arm-In signal from another module in the mainframe. After the first analyzer triggers, it arms the second analyzer. After the second analyzer triggers, it can send a Port-Out signal to the Port-Out BNC on the back panel of the mainframe. This signal can be used to arm an external measurement module, such as an oscilloscope.



ORed Trigger

The ORed trigger allows you to configure two machines to trigger on completely different sets of data and allow either to trigger the other machine to capture data. Let's assume, for example, you have a system with two microprocessors. The system is having problems, and you aren't sure which microprocessor is causing the problem. You can connect one machine to microprocessor 1 and the other machine to microprocessor 2. When one of the machines sees the problem, it will trigger the other, so you have captured parallel data for both machines. This data is time correlated to help you determine the cause of the problem.

Note that the machine receiving the ORed trigger remains in the sequence level it was in when receiving the signal. It does not skip levels to go to the one defining the trigger. The main effect is that the acquisition considered to be the trigger point occurs at the same position in both machines.

Count Field (State and State Compare only)

The Count field accesses a selection menu which stamps the acquisition data at each memory location with either a Time tag or a State count tag. If you have all pod pairs assigned, the state acquisition memory is reduced by half when time or state tags are turned on. You can maintain full memory depth if you leave a pod pair unassigned. This section discusses:

- State Tags
- Time Tags
- Memory Depth Considerations

State Tags

If you select States count, each time the system stores a data record it counts the number of occurrences of a particular combination of states that you specify, until a new data record is stored. The system then stores the count, or "state tag," along with the new data record, and the process repeats. When the measurement is completed, each piece of stored data is displayed with its associated "state tag" count.

State tags displayed this way are RELATIVE to the previous count, or they can be displayed as ABSOLUTE, indicating cumulative counts relative to the trigger point.

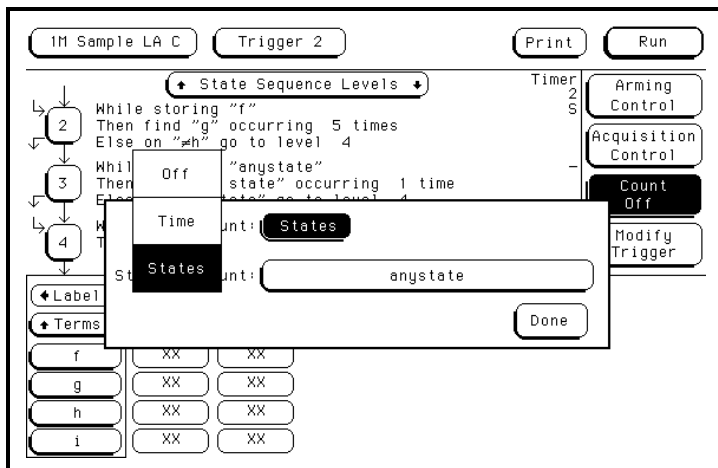

Count Field

Time Tags

If you select Time count, the system places a time stamp on all displayed data. Data stored before the trigger has negative values and data stored after the trigger has positive values. Time tag numbering is set to be either relative to the previous memory location or absolute from the trigger point. Select Absolute or Relative by toggling the Absolute/Relative field. Time tag resolution is 10 ns.

Memory Depth Considerations

If you have all pod pairs assigned, the state acquisition memory is reduced by half when time or state tags are turned on. To retain the full memory depth when using time or state tags, you must have at least one unassigned pod pair.



Acquisition Control Field

The Acquisition Control field accesses an Acquisition Control menu from which you can set the acquisition mode and trigger position within available memory. In a state analyzer you can set whether or not the data that causes a branch to be taken is stored into memory. In a timing analyzer, you can set the sample period.

In a state analyzer, the acquisition control settings are imposed on the qualified data after the trigger has occurred. Depending on what data is qualified in the sequence levels and when the trigger occurred, the additional data qualifying by the acquisition control will result in more efficient use of available memory. Five control fields accessed are from the acquisition control menu:

- Acquisition Mode Field
- Trigger Position Field
- Memory Length
- Reference Clock
- Sample Period (Timing only) or Branches Taken (State and State Compare)

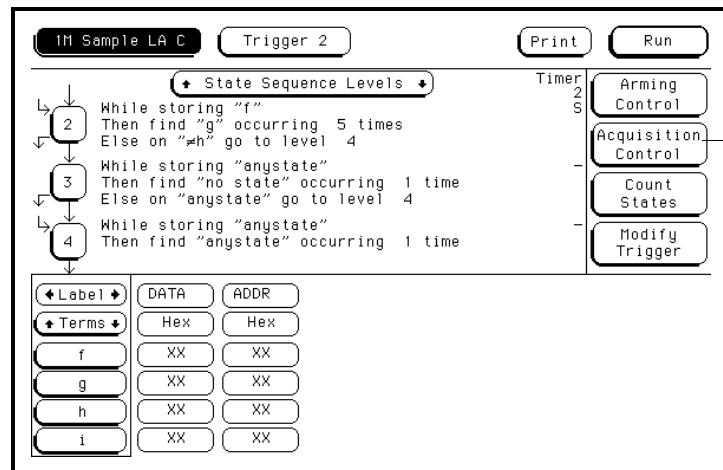

Acquisition Control field

Acquisition Control field

Acquisition Mode Field

The Acquisition Mode field toggles between Automatic and Manual. When set to Automatic in a state analyzer, the trigger position is computed based on the sequence specification. In a timing analyzer, the trigger position and sample period are computed based on the sec/Div and delay settings in the Waveform menu.

When the Acquisition Mode field is set to Manual, additional configuration fields become available. Use these fields to further qualify what data is stored. The additional configuration fields work together with the sequence instructions, in a prioritized manner, to position the trigger point relative to the beginning and end of stored data.

Trigger Position Field

In a state analyzer, the trigger point position is determined after the sequence instructions are evaluated. This process could result in a varying portion of available memory being filled with post-trigger data. The remainder of memory is considered free and is filled with less significant data.

In a timing analyzer, after the specified trigger term is found, memory is filled with post-trigger data starting at the trigger position represented by a blue graphic bar with the "Trig" indicator line. If the trigger position is set to store pre-trigger data, any true sequence instruction or trigger seen is ignored until the proper amount of pre-trigger data has been stored.

The Trigger Position field accesses a selection of options:

- Start
- Center
- End
- User Defined
- Delay

Start When the trigger position is set to Start, it places the trigger near the beginning of memory and most of the data in memory is post-trigger data.

Center When the trigger position is set to Center, the trigger is placed at the middle of memory. Half of the data is pre-trigger data and half is post-trigger data.

End When the trigger position is set to End, the trigger is placed near the end of memory and most of the data in memory is pre-trigger data.

User Defined When the trigger position is set to User Defined, a Post Store field appears which shows what the percentage of the data captured will be post-trigger data. Use this field to set the trigger position between 0% and 100%.

Delay In a timing analyzer, a Delay option is available. Use the Delay field to delay the start of acquisition storage after the trigger. The range of the delay is affected by the sample period but can range between 16 ns to 8 ks. There may be a variable number of stored samples displayed prior to the user-defined delayed start point for acquisition storage.

Memory Length Field

The memory length field lets you specify how much data you want to acquire. Large traces are useful for hunting for trends, but take longer to analyze. Short, focused traces are easier to search through. The exact values available in the Memory Length field depend upon the analyzer configuration. You can change the value using the knob on the HP 16500, or by selecting the field and entering a value. If the entry is not a currently available option, the nearest valid size will be used.

Reference Clock Field

The Reference Clock field lets you specify whether you want to use the internal clock, provided on the module, or an external clock. If you select the external clock, you must connect a clock signal to the module via the Reference Clock In/Out ports on the back. This feature is provided so that you can have several modules running off the same clock. The default is internal.



Caution

Do not exceed 1 V, peak-to-peak, at a maximum voltage offset of 20 V on the Reference Clock In/Out ports.

The Reference Clock is provided so that you can have several modules running off the same clock. Running individual modules off the same Reference Clock prevents data skew, which could cause slight discrepancies between large data sets. The default clock is internal.

See Also

"Connecting the External Reference Clock" in chapter 2, Probing.

Branches Taken Stored / Not Stored (State and State Compare only)

The Branches Taken field is a toggle field which tells the analyzer to store or not to store the resource term that caused the analyzer to branch.

As the analyzer steps through the sequence instructions, it may repeatedly branch to secondary branches because the first resource term was bypassed (false) and the second "Else" resource term is qualified (true). With Branches Taken set to Stored, both the state data values that caused the secondary branches and the secondary branch are stored in memory.

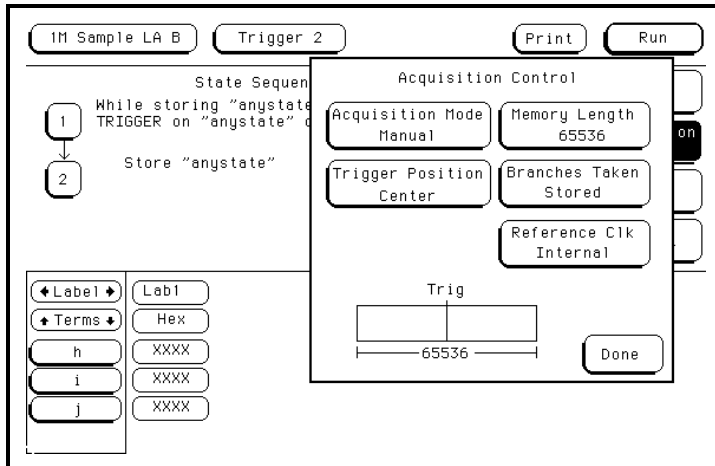

Acquisition Control Menu (State Analyzer)

Sample Period Field (Timing only)

The Sample Period field is used to set the time period between data samples. Every time a new sample is taken, the analyzer will see updated measurement data.

Modify Trigger Field

The Modify Trigger field allows you to modify the statements of any single sequence level as well as other high level actions like global clearing of existing trigger statements, and adding or deleting sequence levels.

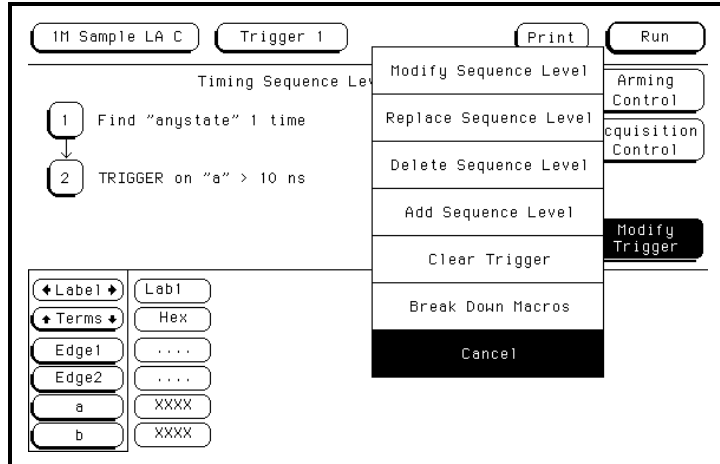

Modify Trigger

Modify Sequence Level

If there is more than one sequence level assigned, you are asked which level to modify. Once in the desired sequence level, make all appropriate resource changes, then select Done.

Replace Sequence Level

If there is more than one sequence level assigned, you are asked which level to replace. When you replace a level, you pick a new macro to replace the old one. You then assign the appropriate resource in the new level.

Delete Sequence Level

If there is more than one sequence level assigned, you are asked which level to delete.

Add Sequence Level

By default you have one sequence level available at powerup. When you add sequence levels, you are given the choice of inserting them before or after a sequence level.

Clear Trigger

The Clear Trigger field accesses a selection menu used to clear any user-defined values within the trigger specification or within the resource terms list.

All The All option resets sequence levels, resource terms, and resource term names to default settings.

Sequence Levels The Sequence Levels option resets all assignment fields in the sequence levels to default values. Custom names assigned to the resource terms will remain.

Resource Terms The Resource Terms option resets all assignment fields for the resource terms to default values.

Resource Term Names The Resource Term Names option resets all custom names assigned to the resource terms to default names.



Break Down Macros / Restore Macros

When a pre-defined macro is broken down, the contents of that macro are displayed in the same long form used in the User-level macro. If the macro uses multiple internal levels, all levels are separated out and displayed in the sequence level area of the Trigger menu. Once the macros in your trigger specification are broken down, the Break Down Macros field changes to Restore Macros. Use the Restore Macros field to restore all macros to their original structure.

While in a broken down form, you can change the structure. However, when the macros are restored, all changes are lost and any branching that is part of the original structure is restored.

Use the Break Down Macros if you want to view a particular macro part in its long form to see exactly what flow the sequencer is following. It can also be used as an aid in creating a custom trigger specification. In this application, you would start with a pre-defined macro, break it down, then customize the long form to meet your needs.

When a macro is broken down, you have all the assignment fields and branching options available as if you have configured a User-level macro. For information on the assignment fields, branching, occurrence counters, and time duration function, refer to the section, "Modifying the User-level Macro" found later in this chapter.



The Listing Menu

The Listing Menu

The Listing menu allows you to display data stored to memory during state or timing analyzer measurements. The acquired data is displayed in the order the analyzer placed the data into analyzer memory and is grouped by label and in a selectable numeric base. Labeled data from other analyzer machines can be interleaved into the same display. You can access three kinds of markers:

- Pattern Markers
- Time Markers
- Statistics Markers

See Also

"Interleaving State Listings" in chapter 10, The Mixed Display Menu, for more information on interleaving state data.

Markers Field

The Markers field is used to access the markers selection menu. When this field is selected, a marker selection menu appears with the choices available for the present analyzer configuration.

State Analyzer Types

In a state analyzer with time and state count turned off in the Trigger menu, only Pattern markers are available. With time count turned on, choices of Pattern, Time, and Statistics markers become available. With States count turned on, Pattern and States markers are available.

Timing Analyzer Types

In a timing analyzer you have marker choices of Pattern, Time, and Statistics.

Off

The Off selection turns marker operations off. If a Stop measurement was previously specified, and the Stop measurement criteria are met, the measurement will stop even though the markers are off.

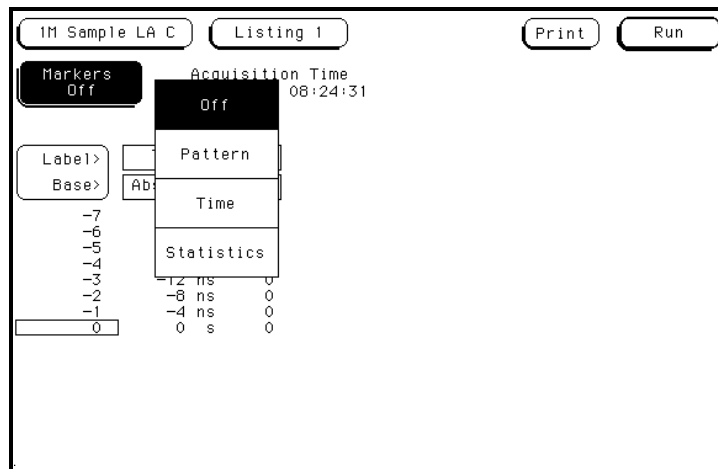

Markers Field

Pattern Markers

When Pattern markers are selected, two markers labeled X and O become available. These markers are used to identify and mark unique bit patterns in the data listing. Once the unique bit patterns are marked, they can be used as reference points or as criteria for a stop measurement.

The markers are color coded for easy recognition in the data listing. The X marker is represented by a horizontal green line and the O marker is represented by a horizontal yellow line.

When a marker is positioned in the Listing menu, it is also positioned in the Waveform menu.

The fields associated with Pattern Markers are:

- Find X-pattern / O-pattern Field
- Pattern Occurrence Fields
- From Trigger / Start / X Marker Field
- Specify Patterns Field
- Label / Base Roll Field
- Stop Measurement Field
- Clear Pattern Field

Find X-pattern / O-pattern Field

The Find X-pattern / O-pattern field is a toggle field. When selected, the target of occurrence and trace start field assignments switches to the other marker. In addition, when this field is selected, the data listing will shift so the data marker will appear at center screen.

Find X-pattern/O-pattern field

The screenshot shows a software interface with a menu bar at the top containing '1M Sample LA C', 'Listing 1', 'Print', and 'Run'. Below the menu bar are several buttons: 'Markers Pattern', 'Find X-pattern', a text field containing '1', 'from Trigger', 'Specify Patterns', and 'Search'. The 'Find X-pattern' button is highlighted. Below these buttons is a table with columns for 'Label>', 'Time', and 'ADDR'. The 'Time' column is further divided into 'Relative' and 'Hex' sub-columns. The table contains data for markers -7 through 0, all with a time of '4 ns' and an address of '0'. The row for marker '0' is highlighted. A line from the text 'Find X-pattern/O-pattern field' points to the 'Find X-pattern' button.

Label>	Time	ADDR
Base>	Relative	Hex
-7	4 ns	0
-6	4 ns	0
-5	4 ns	0
-4	4 ns	0
-3	4 ns	0
-2	4 ns	0
-1	4 ns	0
0	4 ns	0

Find X-pattern / O-pattern Field

Pattern Occurrence Fields

The X-pattern and O-pattern occurrence fields designate which pattern occurrence the marker is placed on. The range for the occurrence counter is the number of samples acquired.

The occurrence field can be set in two ways. When the field is selected one time, it turns light blue and knob operation becomes the entry method. If the field is selected a second time, a pop-up keypad appears and becomes the entry method.

The reference point from which the occurrence counter starts is either the trigger point, the start of the trace, or in the case of the O marker, the X marker. This is set in the From Trigger/Start/Marker field (see next page). If a negative occurrence number is set, the analyzer will search for pre-trigger occurrences.

Occurrence field

Label>	Time	ADDR
Base>	Relative	Hex
-7	4 ns	0
-6	4 ns	0
-5	4 ns	0
-4	4 ns	0
-3	4 ns	0
-2	4 ns	0
-1	4 ns	0
0	4 ns	0

X-pattern and O-pattern Occurrence Fields

From Trigger / Start / X Marker Field

The From Trigger/Start/X Marker field is used to access the selection pop-up for the start point of the X and O marker occurrence counters.

The start points available for the green X marker are either the trace start point or the trigger point.

The start points available for the yellow O marker are either the trace start point, trigger point, or the X marker.

If the marker pattern can not be found, a message appears at the top of the display indicating the search failed. If the O marker is referenced from the X marker, and the X marker is not found, the search for both markers will fail.

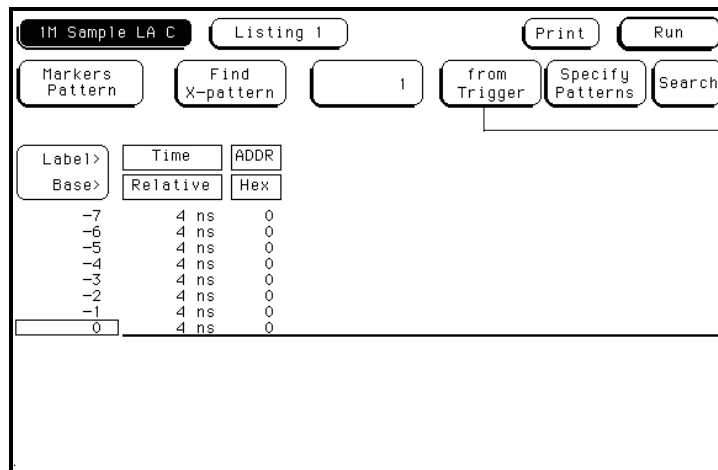

From Trigger/Start/
X Marker field

Trigger/Start/X Marker Field

Specify Patterns Field

The Specify Patterns field appears only when the markers are set to Pattern. When the Specify Patterns field is selected, a pop-up menu appears in which you can assign the bit patterns for the X and O markers, the X and O entering/leaving, and the Stop measurement criteria.

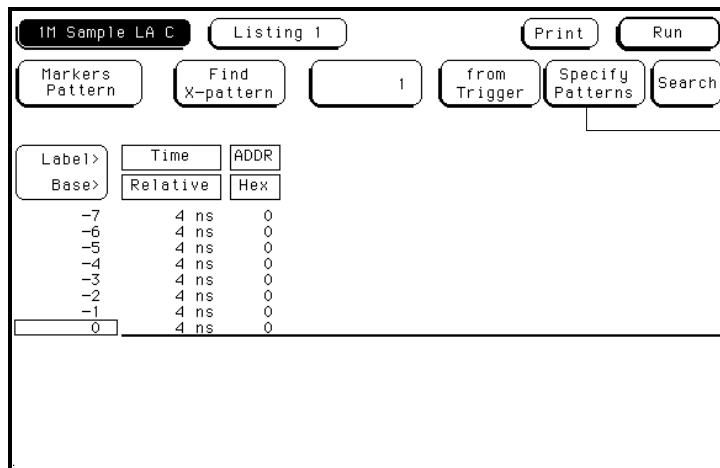

Specify Patterns Field

X and O entering / leaving Fields (Timing only)

If the analyzer is configured as Timing, the X and O pattern markers are placed at either the beginning of the pattern occurrence (entering) or at the end of the pattern occurrence (leaving). When the entering/leaving field of either X or O markers is selected, it toggles between the two choices. Whichever choice you toggle the field to, the pattern you place in the pattern display field will apply to that choice.

X marker and O marker (State only)

If the analyzer is configured as State, X marker and O marker replace the X and O entering/leaving fields. The pattern you place in the pattern display field will apply to the marker labeled at the left.

The screenshot shows a menu with the following elements:

- Buttons: Label>, ADDR, STAT, DATA, Base>, Octal, Hex, Hex, X entering, XX, X, XXXX, O leaving, XX, X, XXXX, Stop measurement Off, Clear Pattern, Done.
- Annotations: A box on the left labeled "X and O entering /leaving fields" points to the "X entering" and "O leaving" buttons. A box on the right labeled "Pattern display fields" points to the "XX", "X", and "XXXX" buttons.

0	0	s	5	0035	0	0035
1	4	ns	5	0035	0	0035
2	8	ns	5	0035	0	0035
3	12	ns	5	0035	0	0035
4	16	ns	5	0035	0	0035
5	20	ns	5	0035	0	0035
6	24	ns	6	0036	0	0036
7	28	ns	6	0036	0	0036
8	32	ns	6	0036	0	0036
9	36	ns	6	0036	0	0036

X and O entering / leaving Fields

Pattern Display Fields

The pattern display fields display the alphanumeric bit pattern specified for each X and O marker in all designated labels. The bit pattern is displayed in the same numeric base and same order as the data listing. When the pattern display field is selected, a pop-up keypad appears which is used to set the bit pattern.

When there are more labels assigned than can be displayed in a single screen, the pattern display fields are rolled back onscreen by selecting the Label/Base roll field and scrolling with the knob.

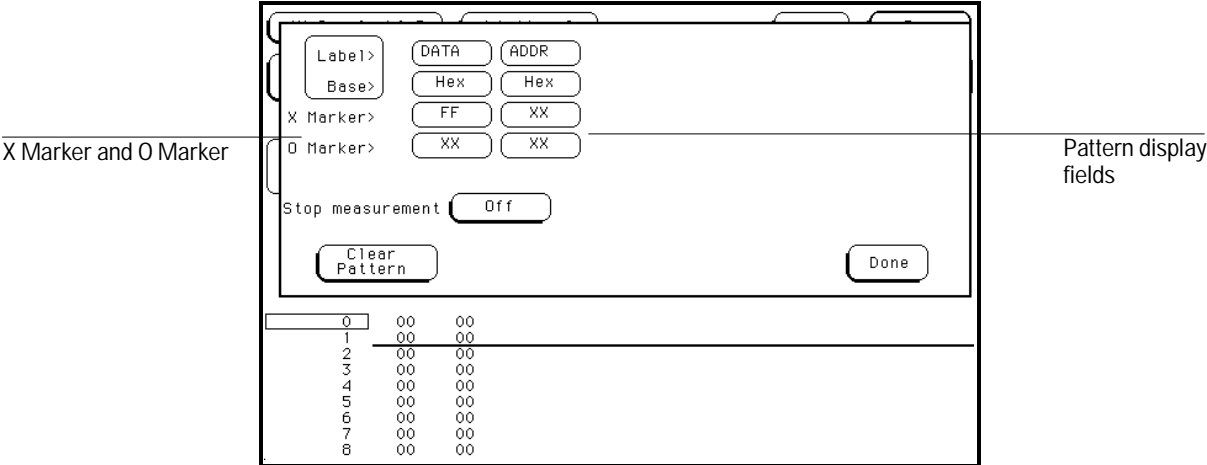

Pattern Display Field

Label and Base Fields

The Label and Base fields show up together in all menus except the Format and Configuration menus. When a new label is assigned, a base field is automatically assigned to that label.

Label Field Labels in the Specify Patterns menu will be displayed throughout the analyzer as they were assigned in the Format menu.

To reorder currently displayed labels, select the label you want to move, then from the selection menu that appears, choose the label you want to switch positions with.

Base Field The function of the Base field is the same in all menus. To change the numeric base, select the base field, then choose the desired base from the selection menus.

Label / Base Roll Field

The rolling function is the same for all items that are stored offscreen. For more information on rolling labels, base, and pods, refer to "Labels Assignment" in the "Common Module Operations" chapter of the *HP 16500 User's Reference* for complete information.

Stop Measurement Field

The Stop measurement function allows you to specify a condition which stops the analyzer measurement during a repetitive run. If two analyzers are configured, both analyzers will stop when either specified stop condition is satisfied.

When the Stop measurement field is selected, a Stop measurement type menu appears. Depending on the analyzer configuration, you have the choices of Off, X-O, and Compare.

Off

The Off selection turns all Stop measurement operations off. If the Stop measurement operation is not turned off and the stop criteria are met, the measurement will stop even though the markers are set to other types or turned off.

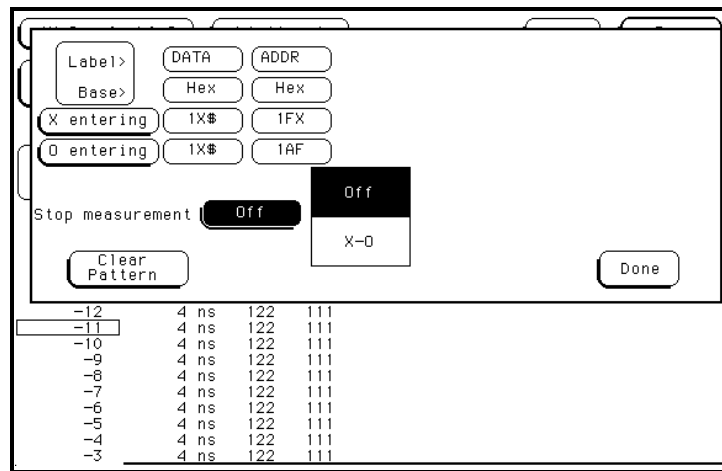

Stop Measurement Field

X-O

The X-O option is available in the timing analyzer, and in the state analyzer with its count set to Time. When X-O is selected, a repetitive run is stopped when a comparison of the time period between the X and O markers and one of the following time period options is true:

Less Than X-O time must be less than the time value that you specify in the Time field.

Greater Than X-O time must be greater than the time value that you specify in the Time field.

In Range X-O pattern must be within the time range value that you specify in the two Time fields.

Not in Range X-O pattern must not be within the time range value that you specify in the two Time fields.

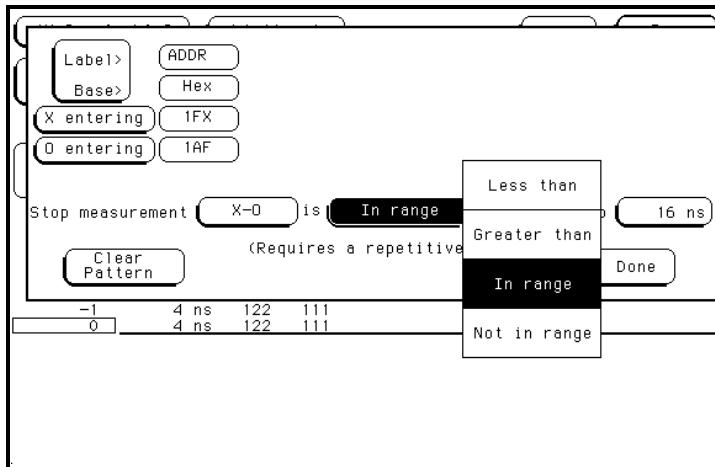

X-O Field

Clear Pattern Field

The Clear Pattern field is used to reset the X and O Marker pattern display fields to default (don't care = X). The Clear Pattern field accesses a selection menu with the choices of All, X pattern, or O pattern.

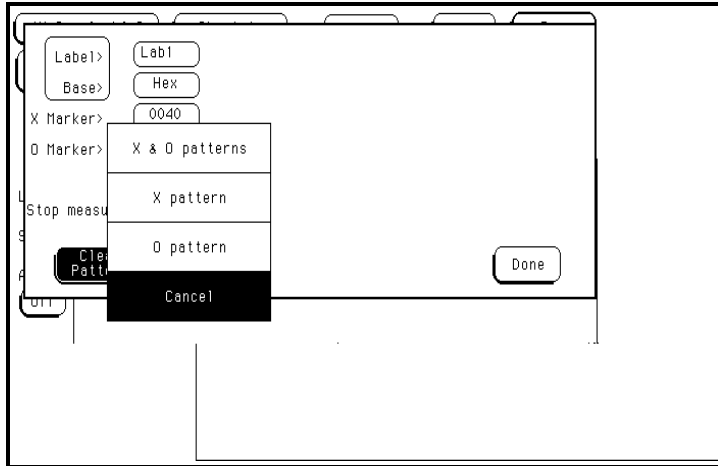

Clear Pattern

Time Markers

Time markers are indicators in the data listing that are used as reference marks to obtain time values between markers or between each marker and the trigger point.

In a state analyzer, time markers become available only when the Count field is set to Time in the Trigger menu.

The markers are color-coded for easy recognition. The X marker is represented by a horizontal green line and the O marker is represented by a horizontal yellow line.

If pattern markers have been assigned, the time markers will be placed initially at the same locations in the data listing. You can set values for time markers using the following fields:

- Trig to X / Trig to O Fields

Trig to X / Trig to O Fields

The Trig to X and Trig to O fields are both display and configuration fields. Set the marker position by selecting the fields, then, after the fields turn light blue, rotate the knob. You can also set the marker position by selecting the light blue field a second time and entering a value using the pop-up keypad. The Trig to X and Trig to O fields display the time between the trigger point and the marker.

X to O Display Field

The X to O display field is a "read only" field that displays the time between the X and O markers. As the X and O markers are changed, the display changes accordingly.

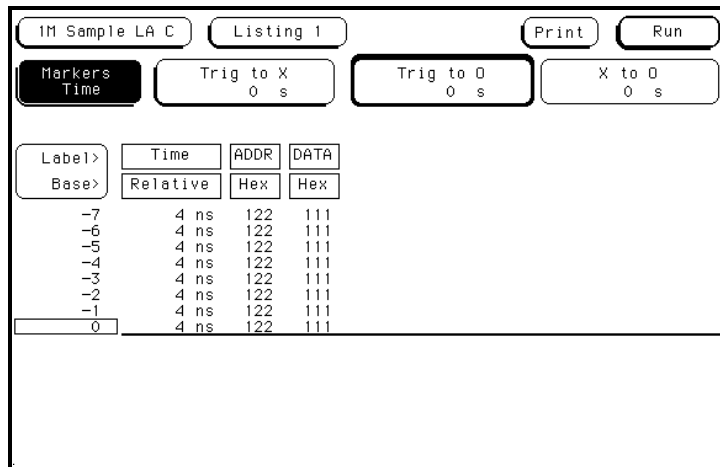

Trig to X / Trig to O Fields

Statistics Markers

After you have assigned patterns to the X and O markers, statistical information is available when you set markers to Statistics. The logic analyzer displays the following information:

- Number of valid runs (runs where Pattern markers were able to be placed on specified patterns).
- Minimum time between the X and O Pattern markers.
- Maximum time between the X and O Pattern markers.
- Average time between the X and O Pattern markers.

In a state analyzer, Statistics markers become available only when the Count field in the Trigger menu is set to Time.

The markers are color-coded for easy recognition in the data listing. The X marker is represented by a horizontal green line and the O marker is represented by a horizontal yellow line.

The Listing Menu Trig to X / Trig to O Fields

Statistics are based on the time between the X and O markers, therefore both markers must be found before valid statistical information is displayed.

In repetitive run mode, the display is updated each time a valid run occurs until you select Stop. If you select Run after selecting Stop, the statistics continue to update without loss of information.

In single run mode, each time you select Run an additional valid run will be added to the data and the statistics will be updated. This process continues unless you change the placement of the X and O Pattern markers between runs.

Statistics display

Label>	Time	ADDR	DATA
Base>	Relative	Hex	Hex
-7	4 ns	122	111
-6	4 ns	122	111
-5	4 ns	122	111
-4	4 ns	122	111
-3	4 ns	122	111
-2	4 ns	122	111
-1	4 ns	122	111
0	4 ns	122	111

Statistics Display

Data Roll Field

The column of numbers at the far left represents the location of the acquired data in the state analyzer's memory. The numbered positions are also known as the state locations and are relative to the trigger state location. The column of state location along with its data can be rolled to display other data by using the data roll field.

The data roll field is the small rectangular box located in the middle of the state location column. The data roll field is used to either roll the data listing or to select an exact state for display. When the data roll field is light blue, the knob is active and can roll data in either direction.

If you touch the data roll field when it is light blue, a pop-up keypad appears for the number of an exact state. When the pop-up keypad is used, the data listing shifts, leaving the selected state in the light blue data roll box.

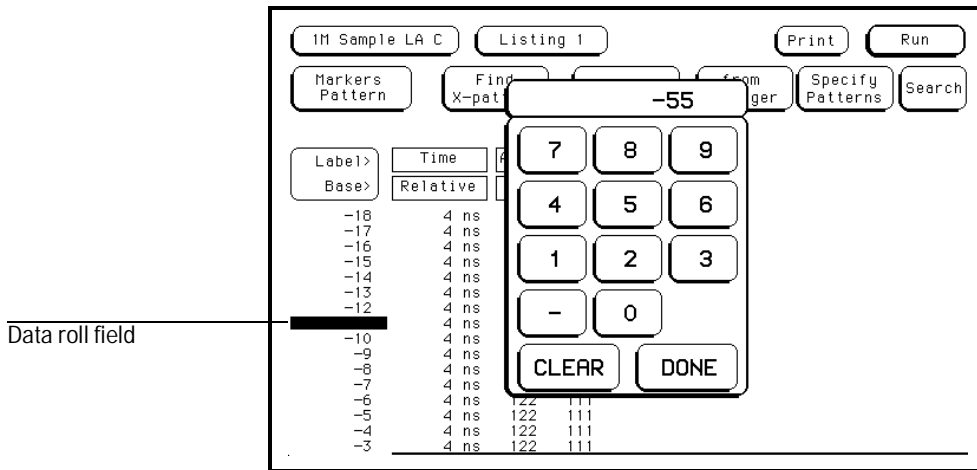

Data Roll Field



The Waveform Menu

The Waveform Menu

Use the Waveform menu to view state or timing data in a format similar to an oscilloscope display. Data is displayed with the horizontal axis representing either states (if operating in state mode) or time (if in timing mode), and the vertical axis representing logic highs and lows. In state mode, the analyzer displays state data in reference to the trigger point, with the horizontal resolution being states per division. In timing mode, the analyzer displays timing data in reference to the trigger point with the horizontal resolution being time per division. The Waveform Menu includes the following controls and markers:

- Basic Controls
- Pattern Markers
- Time Markers
- Waveform Display

Basic Controls

The basic controls on the initial Waveform screen let you configure this display using the following controls:

- Acquisition Control Field
- Accumulate Field
- States Per Division Field (State only)
- Seconds Per Division Field (Timing only)
- Delay Field
- Sample Period Display (Timing only)
- Markers Field



Acquisition Control Field

The function of the Acquisition Control field in the Waveform menu is the same as in the Trigger menu. Refer to the "Acquisition Control Field" in chapter 5, "The Trigger Menu" for complete details.

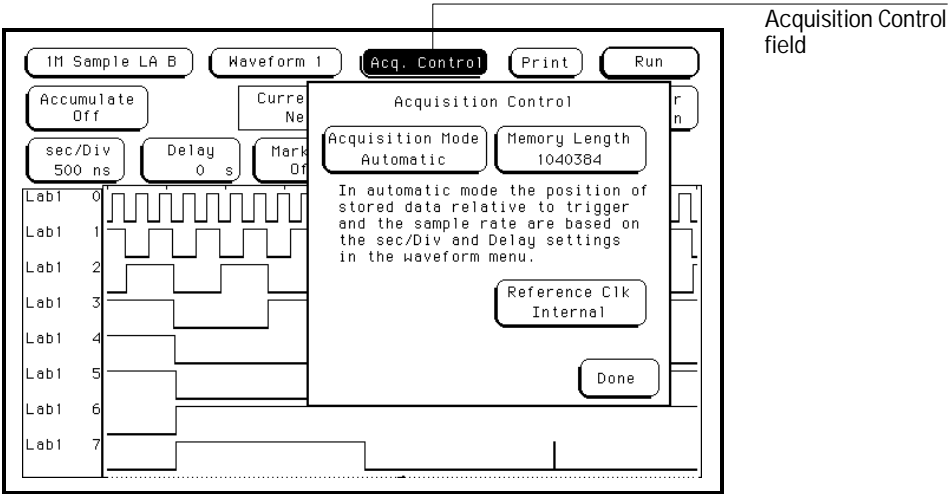

Acquisition Control Field

Accumulate Field

The Accumulate field controls whether old data is cleared or displayed with new data. The Accumulate field will toggle On/Off. When Accumulate is on, the analyzer displays the data from a current acquisition on top of the previously acquired data.

The time at which the old data is cleared depends on whether the analyzer is run in Single or Repetitive mode. In Single mode, new data will be displayed on top of the old data each time the Run field is selected. In Repetitive mode, data is cleared from the screen only when you start a run after stopping an acquisition with the Stop field.

If you leave the Waveform menu or pop up a menu over the waveform display, any accumulated display data is lost and the accumulation process starts over.

Accumulate field

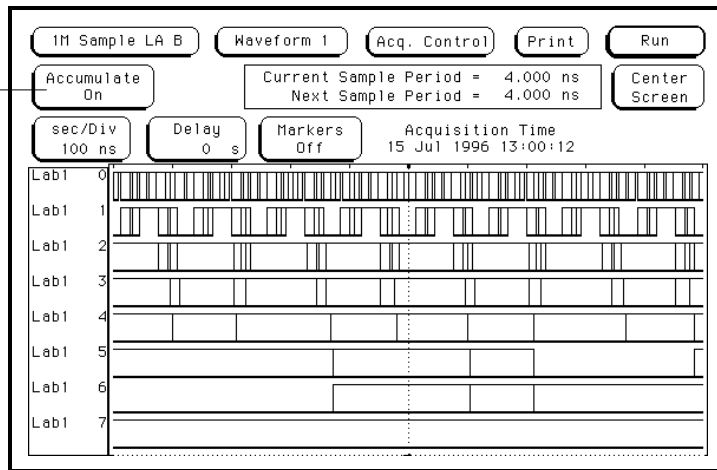

Accumulate Field

States Per Division Field (State and State Compare only)

When you set the analyzer Type field in the Configuration menu to State or State Compare, the analyzer uses external clocks from the system under test. In this mode, the X-axis of the waveform display is measured in states per division.

Use the states/Div field to select the states per division resolution of the X-axis. You can specify between 1 state per division to one-eighth the memory length for states per division by touching the states/Div field and rotating the knob or by touching the states/Div field twice and using the pop-up keypad. By adjusting the states/Div, you can zoom in to view a desired part of the display.

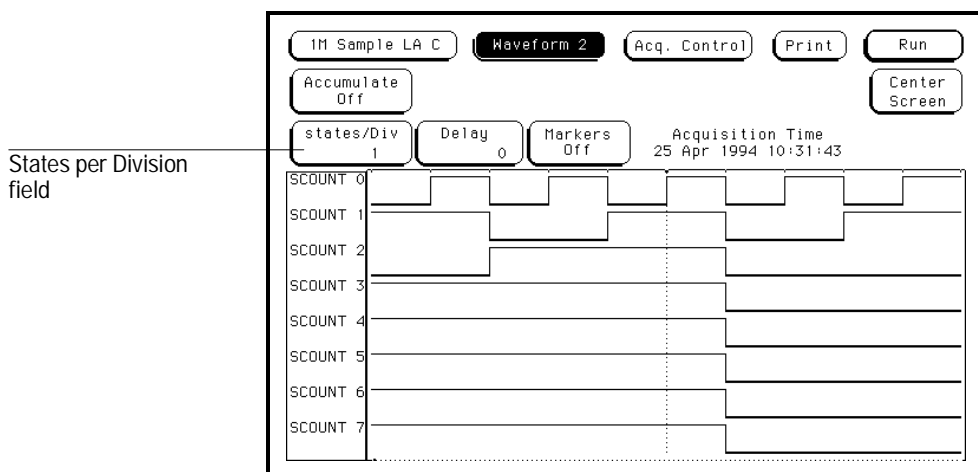

States Per Division Field

Seconds Per Division Field (Timing only)

When you set the analyzer Type field in the Configuration menu to Timing, the analyzer uses its own internal clock. In this mode, the X-axis of the waveform display is measured in seconds per division (sec/Div).

Use the sec/Div field to select the seconds per division resolution of the X-axis. The range of the sec/Div field is 1 ns/Div to 4.4 s/Div for the HP 16556A or 2.2 s/Div for the HP 16556D. In half-channel mode, the upper range of the limit is halved. You set the sec/Div field either by touching the sec/Div field and rotating the knob or by touching the sec/Div field twice and then using the pop-up keypad.

When using the knob to set the sec/Div, the value will change in a 1-2-5 sequence. By adjusting the sec/Div, you can zoom in to view a desired part of the display.

Seconds per Division field

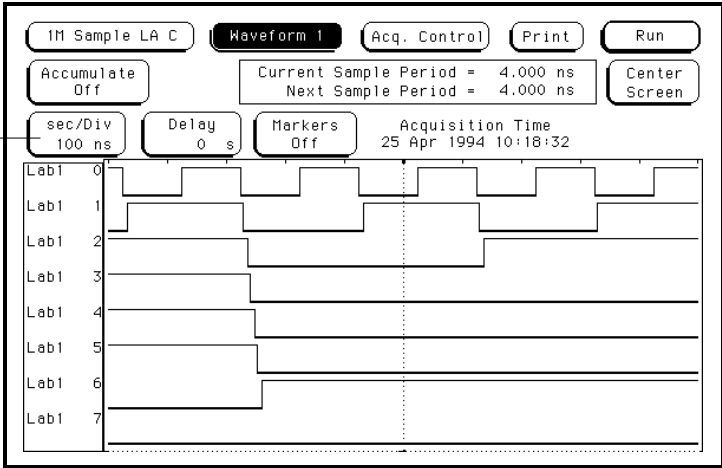

Seconds Per Division Field

Delay Field

Depending on the analyzer configuration, you can set a positive or negative delay measured in either states or time. The Delay field allows you to scroll the data and place the display window desired at center screen. Changing the delay will not affect the next data acquisition unless it is a timing analyzer and the acquisition mode is automatic.

The delay range of a timing analyzer is from -2500 seconds to + 2500 seconds. The delay range of a state analyzer is set by the memory length. You can set the value in the delay field to plus or minus the total memory length.

If you want to move the display window to view data located offscreen to the right, enter a positive delay. If you want to move the display window to view data located offscreen to the left, enter a negative delay.

You can enter a delay using the knob by selecting the Delay field once, which turns it light blue, and then turning the knob. If you select the Delay field a second time, when it is light blue, a pop-up keypad appears which enables you to enter an exact number.

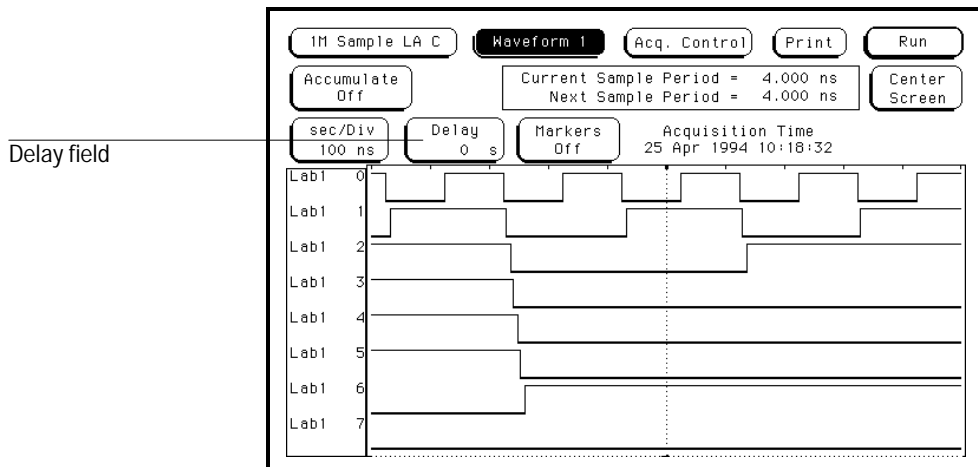

Delay Field

Sample Period Display (Timing only)

The Sample period display only appears in a timing analyzer. A sample period is the interval of time between new data samples. Every time a new sample is taken, the analyzer updates the measurement.

The Current Sample period display is the sample period used for the last acquisition. The Next Sample period is the new sample period to be used at the next acquisition. If the acquisition mode is set to automatic, changing the sec/Div or delay will affect the sample period for the next acquisition.

Sample period display

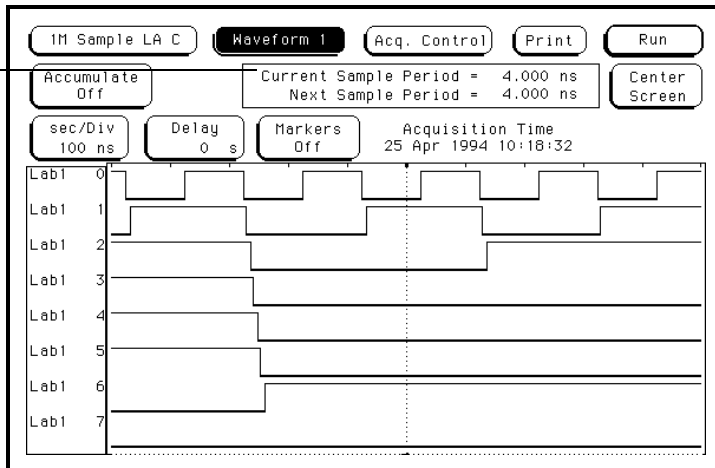

Sample Period Display

The Waveform Menu
Sample Period Display (Timing only)

Timing waveforms are reconstructed with respect to the sample period. A shorter sample period puts more sample points on the waveform for a more accurate reconstruction, but also fills memory quicker.

If the sec/Div is changed, resulting in a change in the next sample period, you must run the analyzer again before the current sample period display is updated.

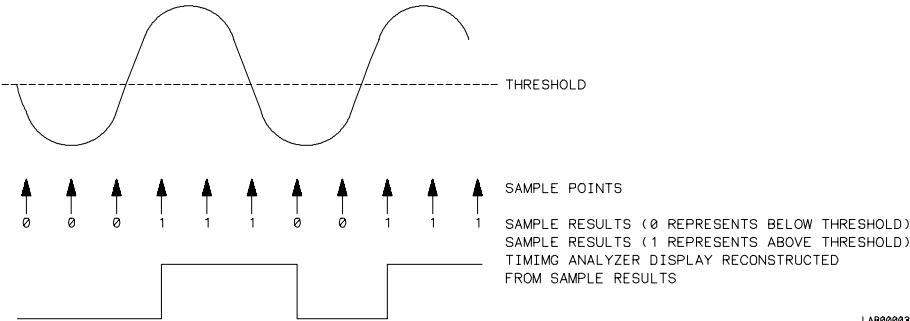

Sample Points

Markers Field

The Markers field is used to access the markers selection menu. When the Markers field is selected, a marker selection menu appears with the marker choices available under the present analyzer configuration.

State Analyzer Markers

In a state analyzer with time and state count turned off in the Trigger menu, only Pattern markers are available. With time count turned on, choices of Pattern, Time, and Statistics markers become available.

With states count turned on, Pattern and State markers are available.

Timing Analyzer Markers

In a timing analyzer you have marker choices of Pattern, Time, or Statistics.

Off

The Off selection turns marker operations off. If a Stop measurement was previously specified and the Stop measurement criteria are met, the measurement will stop even though the markers are off.

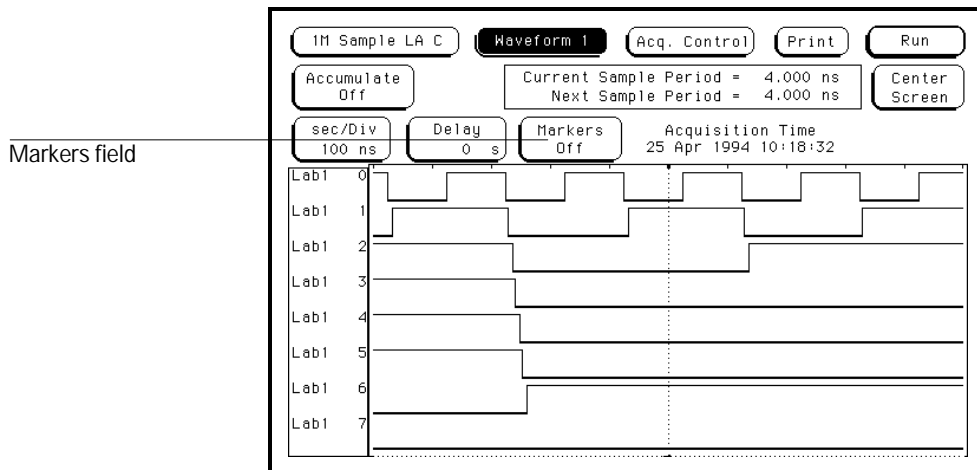

Markers Field

Pattern Markers

When Pattern markers are selected, two markers labeled X and O become available. You can use these markers to identify and mark unique bit patterns in the waveform display. Once the unique bit patterns are marked, you can use them as reference points or as criteria for a stop measurement.

The markers are color-coded for easy recognition in the waveform display. The X marker is a vertical green line, and the O marker is a vertical yellow line. When a marker is positioned in the waveform display, it is also positioned in the data listing display. You control pattern markers with the following fields:

- X-pat / O-pat Occurrence Fields
- From Trigger / Start / X Marker Field
- X to O Display Field (Timing only)
- Center Screen Field
- Specify Patterns Field
- X and O entering / leaving Fields (Timing only)
- Pattern Display Fields
- Label and Base Fields
- Label / Base Roll Field
- Stop Measurement Field
- Clear Pattern Field

X-pat / O-pat Occurrence Fields

The X-pattern and O-pattern occurrence fields designate which pattern occurrence the marker is placed on. The range for the occurrence counter depends on the logic analyzer model and the memory depth selected. If you enter a number outside the range, the closest valid number will be substituted.

The occurrence field can be set in two ways. When the field is selected one time, it turns light blue and the knob becomes the entry method. If the field is selected a second time, a pop-up keypad appears and becomes the entry method.

The reference point from which the occurrence counter starts is either the trigger point, the start of the trace, or in the case of the O marker, the X marker. If a negative number is set, the analyzer will search for pre-trigger occurrences.

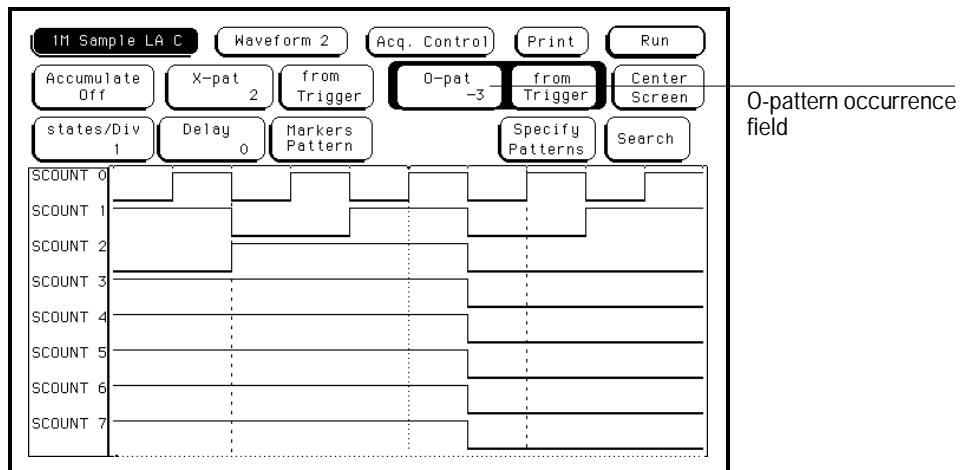

X-pattern and O-pattern Occurrence Fields

From Trigger / Start / X Marker Field

The From Trigger/Start/X Marker field is used to access the selection pop-up for the start point of the X and O marker occurrence counters.

The start points available for the green X marker are either the trace start point or the trigger point.

The start points available for the yellow O marker are the trace start point, the trigger point, or the X marker.

If the marker pattern cannot be found, a message appears at the top of the display indicating the search failed. If the O marker is referenced from the X marker, and the X marker is not found, the search for both markers will fail.

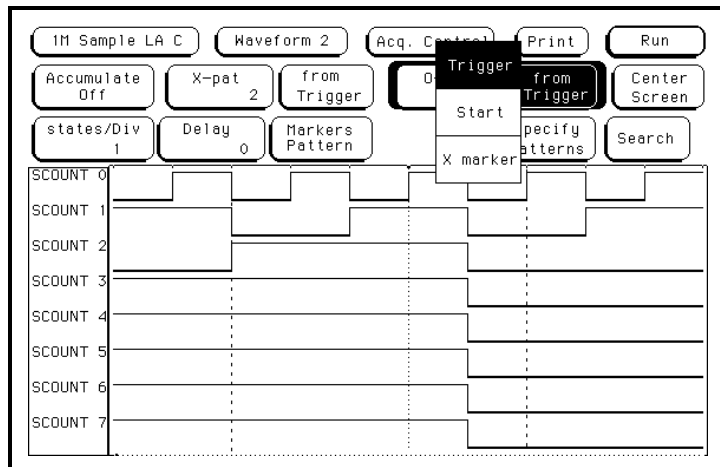

Trigger / Start / X Marker Field

Center Screen Field

The Center Screen field accesses a menu which allows you to position the marked points of the waveform display relative to the center of the waveform display.

About Trigger The About Trigger selection is the default position. This choice will position the trigger at center screen.

About X Marker This choice adjusts the delay to position the X marker at center screen.

About O Marker This choice adjusts the delay to position O marker at center screen.

About X & O This choice adjusts the sec/Div to allow both X and O markers to be displayed simultaneously.

About Start This choice adjusts the delay to position the start of the data record at the center of the screen.

About End This choice adjusts the delay to position the end of the data record at the center of the screen.

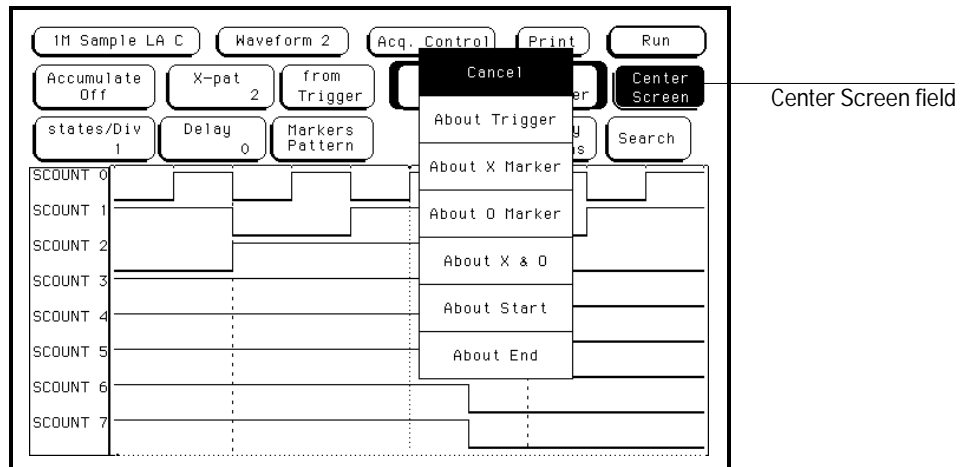

Center Screen Field

Specify Patterns Field

The Specify Patterns field only appears when the markers are set to Pattern. When the Specify Patterns field is selected, a pop-up menu appears in which you can assign the bit patterns for the X and O markers, the X and O entering/leaving, and the Stop measurement criteria.

The Specify Patterns field functions exactly like the Specify Patterns field in the Listing menu. For more information on the fields in the pop-up menu attached to the Specify Patterns field, see "Specify Patterns Field" in chapter 6, "The Listing Menu."

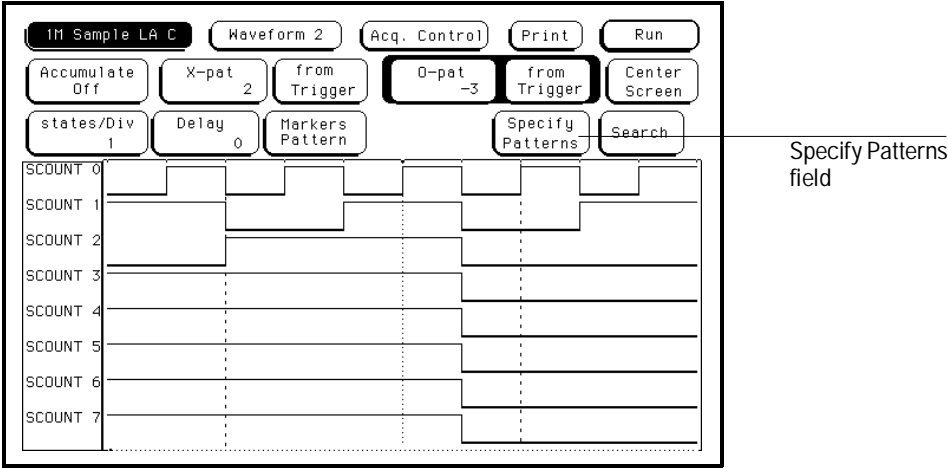

Specify Patterns Field

Time Markers

Time markers are indicators located in the waveform display that are used as reference marks to obtain time values between markers, or between each marker and the trigger point.

In a state analyzer, Time markers only become available when the Count field is set to Time in the Trigger menu.

The markers are color-coded for easy recognition in the waveform display. The X marker is represented by a vertical green line and the O marker is represented by a vertical yellow line.

If Pattern markers are assigned, the Time markers are initially placed at the same locations in the data listing.

Time markers have two fields for control and display:

- Trig to X/Trig to O Fields
- Marker Label/Base and Display



Trig to X / Trig to O Fields

The Trig to X and Trig to O fields display the time between the trigger point and the marker. They are also used to position the markers with reference to the vertical red trigger line.

Set the marker position by selecting the Trig to X and Trig to O fields, then, after the fields turn light blue, rotate the knob. In addition, values can be entered by selecting the light blue field a second time, then using the pop-up keypad that appears.

X to O Field

In a state analyzer configuration, the X to O field is a "read only" field that displays the difference between the X and O markers. As the X and O markers are changed, the display changes accordingly.

In a timing analyzer configuration, you can select and set the X to O field. If this field is changed, both X and O markers will move simultaneously with the relative difference remaining unchanged.

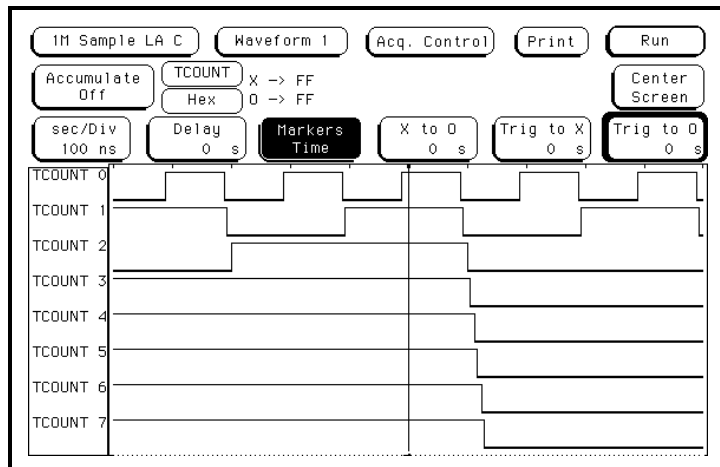

Trig to X / Trig to O Fields

Marker Label / Base and Display

The label field displays the label name for which the X and O marker values are assigned. To display other labels, select the label field and choose the new label from the selection menu that appears. Only pre-assigned labels are available in the label selection menu.

The base field underneath the label field displays the numeric base of the marker values. To change the numeric base, select the base field, then choose the desired base from the selection menu. Bit patterns where the markers are currently placed, appear next to the appropriate marker.

See also

"Labels Assignment" in the "Common Module Operations" part of the *HP 16500 User's Reference* for complete information on assigning labels.

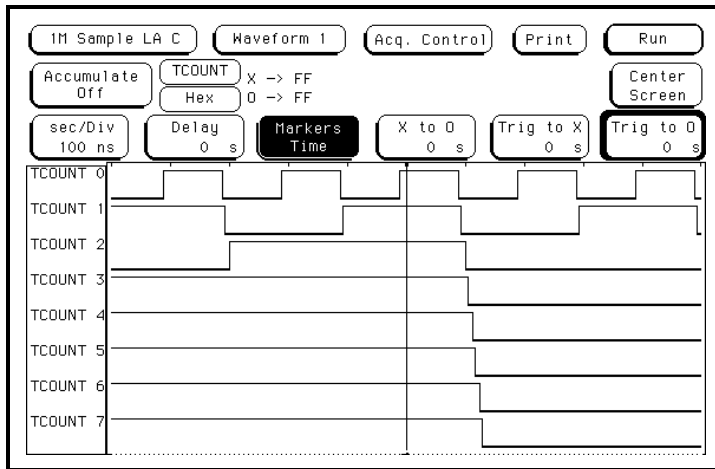

Marker Label / Base and Display

Statistics Markers

After patterns are assigned to the X and O markers, statistical information is available when you set the markers to Statistics. The logic analyzer displays the following information:

- Number of valid runs (runs where Pattern markers were placed on specified patterns).
- Minimum time between the X and O Pattern markers.
- Maximum time between the X and O Pattern markers.
- Average time between the X and O Pattern markers.

In a state analyzer, Statistics markers only become available when the Count field is set to Time in the Trigger menu.

The markers are color-coded for easy recognition. The X marker is represented by a vertical green line and the O marker is represented by a vertical yellow line.

The statistics generated are based on the time between the X and O markers. Both markers must be found before valid statistical information is displayed.

In repetitive run mode, the display is updated each time a valid run occurs until you press Stop. If you press Run after pressing Stop, the statistics continue to update without loss of information. All statistical information can be cleared at any time by selecting the Reset Statistics field.

In single run mode, each time you press Run an additional valid run will be added to the data and the statistics will be updated. This process continues unless you change the placement of the X and O Pattern markers between runs.

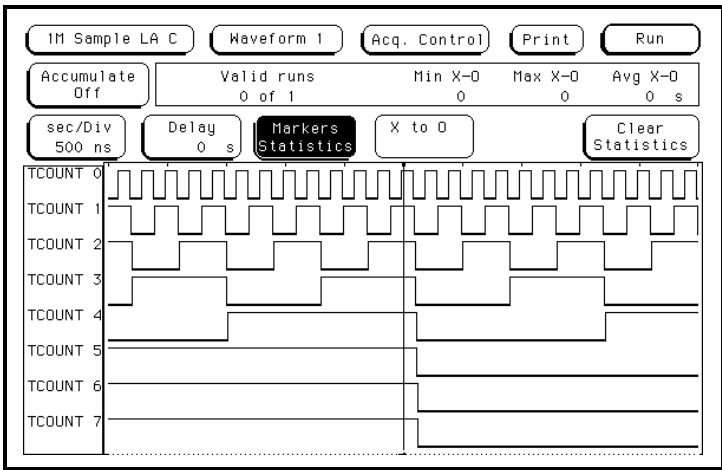
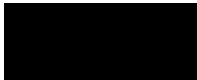

Statistics Display

Waveform Display

The waveform display area of the Waveform menu displays state and timing waveforms for labels assigned in the Format menu. If the Waveform menu is from a state analyzer, the display is state waveforms. If the Waveform menu is from a timing analyzer, the display is timing waveforms.

Selecting waveforms for display, and modifying or deleting waveforms is identical for both state and timing waveforms. This area also accesses the following fields used to select, delete, or modify waveforms:

- Display Location Reference Line
- Blue Bar Field
- Channel Mode Field
- Module and Label Fields
- Action Insert/Replace Field
- Delete and Delete All Fields
- Waveform Size Field

Only waveforms with their bits assigned in the Format menu can be displayed. Each waveform is a member of a set of waveforms grouped under a label. The label name you assign in the Format menu is the label name that appears in the Labels selection list.

Display Location Reference Line

At the bottom of the Waveform menu is a reference line that displays the relative location of the display window, the markers, and the trigger point with reference to the total memory.

Total memory is represented by a horizontal dotted line. The display window is represented by an overlaid solid line. The markers and trigger point are represented by colored dots on the dotted line representing the total memory space. The trigger point is represented by a red dot, the X marker by a green dot, and the O marker by a yellow dot.

Blue Bar Field

The blue bar on the left side of the waveform display is both a display and configuration field. After all desired waveforms are configured for display, they are listed in the blue bar. If there are more waveforms than can be displayed, you can scroll through the list by selecting the dark blue bar, and, after it turns light blue, by turning the knob.

If the blue bar is already light blue, just turn the knob. If the blue bar is selected when it is light blue, the Waveform Selection menu appears. Use the waveform selection menu to configure the waveform display.

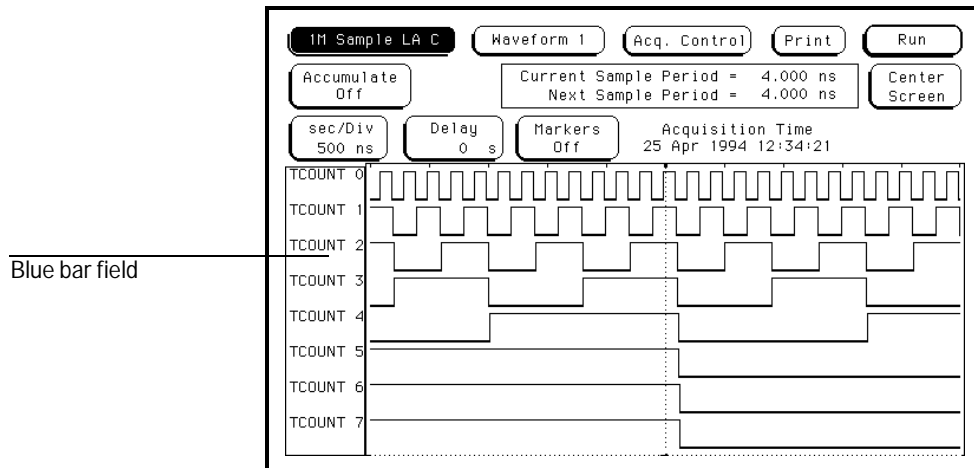

Blue Bar Field

The Waveform Menu Channel Mode Field

When the Waveform Selection pop-up menu appears, you can select which waveforms are displayed, replaced, or modified. You can display a maximum of 24 waveforms onscreen at one time.

Single waveforms or all waveforms under a label can be displayed or turned off. How the waveform bits are assigned for display depends on what Channel Mode is currently selected.

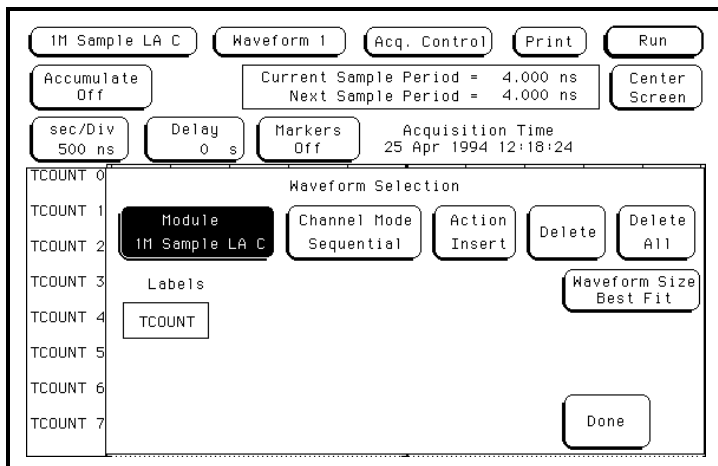

Waveform Selection Menu

Channel Mode Field

The Channel Mode field selects the method by which waveform labels are inserted into the display. All inserted labels are placed below the cursor in the blue bar field. When the Channel Mode field is selected, a selection menu appears with the choices described in the following paragraphs.

Individual

The Individual mode inserts selected channels from a label's channel selection list. The channel selection list appears when a label name is selected. Channels are inserted starting below the white cursor.

Sequential

The Sequential mode inserts all channels from the selected label in order starting below the white cursor.

Overlay

The Overlay mode inserts all bits of a label in a single waveform to form a composite waveform label. The onscreen indication for the Overlay mode is "All" following the label name.

Viewing State Data in Overlay Mode

When all assigned waveforms in a label are overlaid, the value of the data is displayed to the right of each new transition in the waveform display.

If the sec/Div is set to view a large increment of time, or the waveform scaling is set to small or medium, the state data readout will not fit between transitions. To display the state data readouts within the waveform, expand the sec/Div and use the large waveform setting. If symbols are assigned to represent data values, the symbol is displayed.

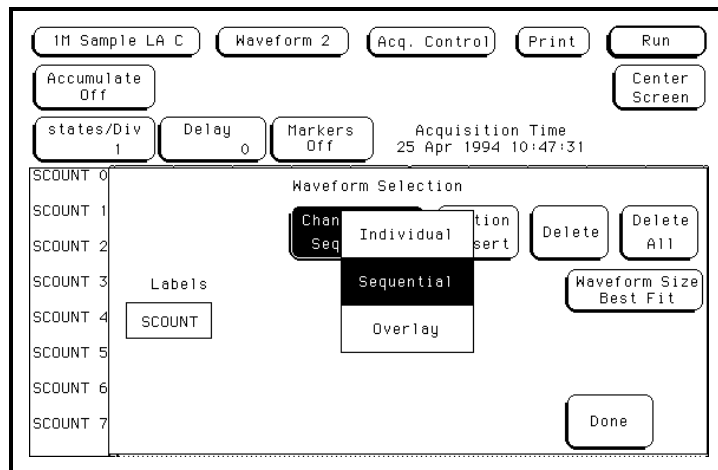
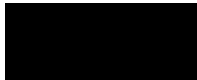

Channel Mode Selection Menu

Module and Label Fields

If there are multiple timing analyzer or oscilloscope modules installed in the mainframe, this field will appear in the menu, and waveforms from the other modules can be displayed in the waveform menu. The Module field accesses a selection list. This list contains the modules installed in the mainframe that are configured in a Group Run, and that have timing or oscilloscope waveforms.

Action Insert/Replace Field

Use the Action field to insert a label or channel into the display or to replace a label or channel.

Insert will append the selected label or channel to the end of the list of displayed labels.

To replace one waveform with another, use the knob to position the cursor on the waveform you want to replace. Touch the Action Insert field to toggle it to Action Replace. Then select the label that will replace the old label.

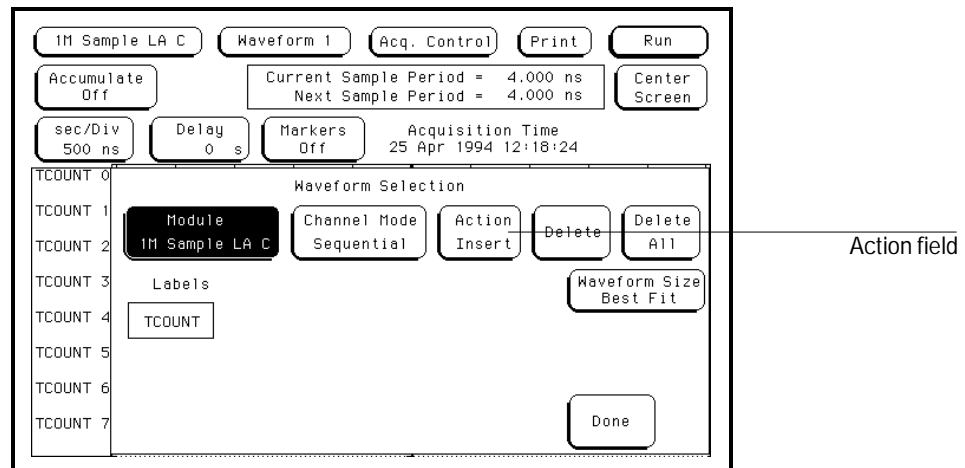

Action Insert/Replace Field

Delete and Delete All Fields

Use the Delete field to delete single channels within the group of displayed waveforms. To delete a single channel, first highlight the desired channel by placing the cursor on the channel, then select the Delete field.

You can delete all currently displayed waveforms by selecting Delete All, then selecting Continue.

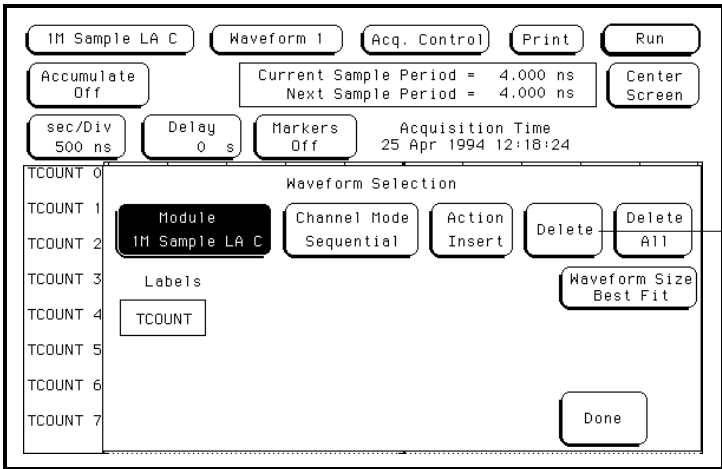

Delete field

Delete Field

Waveform Size Field

The Waveform Size field accesses a selection menu which contains choices that scale the displayed waveforms to different sizes. Use this feature to increase the number of waveforms in the display or to make viewing better for several waveforms.

Best Fit

When Best Fit is used, the analyzer picks the largest font, either small, medium, or large, that allows all waveforms to be displayed.

Small

The small font will allow 24 waveforms to be displayed.

Medium

The medium font will allow 16 waveforms to be displayed.

Large

The large font will allow 8 waveforms to be displayed.

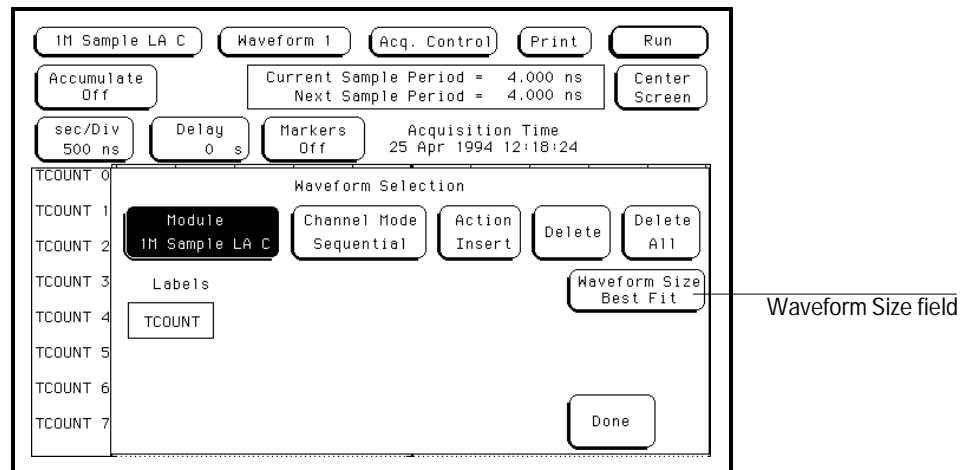

Waveform Size Selection Menu



The Chart Menu

The Chart Menu

Chart is a software post-processing feature that provides the ability to build XY graphs of label activity using state data. The Chart menu is only available when an analyzer is set to State or State Compare type.

The Y axis of the Chart mode always represents data values for a specified label. You can select whether the X axis represents states (rows in the Listing menu) or the data values for another label.

Chart Post-Processing Features

- When the X axis is set to State, X and O markers are available which can be used to search for specific data patterns or document time intervals of interest in timing mode. They can also gather statistics on the time between specific patterns in timing mode.
- Marker placement is synchronized with the Listing and Waveform menus.
- An accumulate mode is available that allows the chart display to build up over several runs.
- You can set a range of data to plot which scales both the axes to selectively view only data of interest.
- You can generate XY plots of Label versus Label or Label versus State.

Label Value Versus Label Value Charts

When labels are assigned to both axes, the chart shows how one label varies in relation to the other for a particular trace record. Label values are always plotted in ascending order from the bottom to the top of the chart and in ascending order from left to right across the chart. Plotting a label against itself will result in the plotted points falling along a diagonal line from the lower-left to upper-right corner. X and O pattern markers are disabled when operating in the label versus label mode.

Label Value Versus State Charts

The Label value versus State chart is a graph of label activity versus the memory location in which the label data is stored. The label value is plotted against successive analyzer memory locations.



The Y Markers

Y1 and Y2 Fields

The Y1 and Y2 markers are used for rescaling data on the vertical axis. Assigning values to these fields can be accomplished in either of two ways. When the field is selected the first time, it turns light blue and operating the knob will change the Y marker value. If the field is selected a second time, a pop-up keypad appears and becomes the entry method for the Y marker value. The Y1 and Y2 markers may be used to zoom in on data of interest in the vertical range. To do this, touch the Rescale field, then select "between Y axis markers." For more information on rescaling data, refer to the "Rescale Field" section later in this chapter.

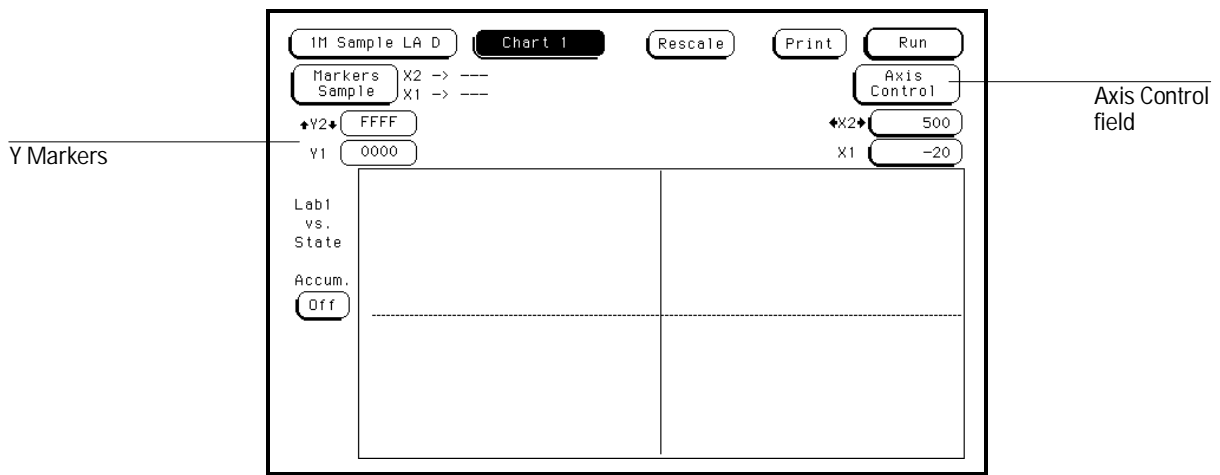

Y Markers for Rescaling the Vertical Axis

The X Markers and the Markers Field

The Markers field is used to access the markers selection pop-up menu. The choices available depend on the Count field in the Trigger menu. With Count Off, only Sample and Pattern are available. With Count Time, Sample, Pattern, Time, and Statistics are available. With Count States, Sample, Pattern, and States are available.

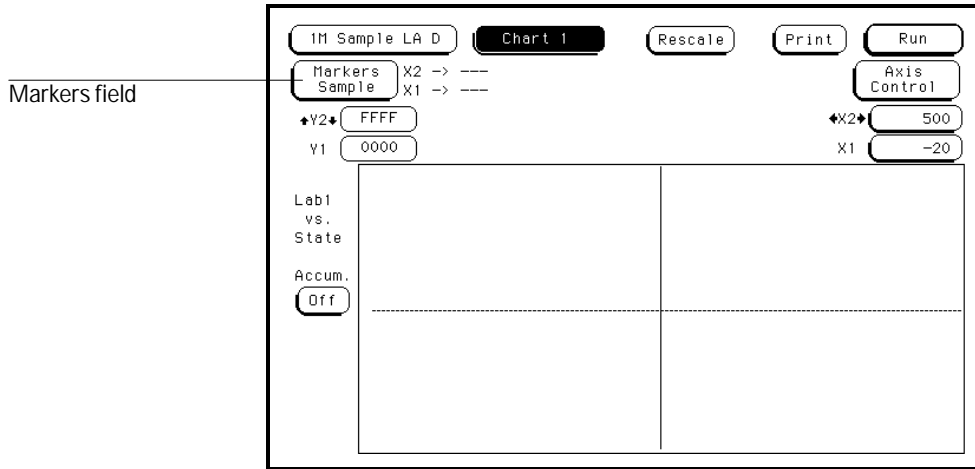

Markers Field

Sample

The Sample selection turns X and O marker operations off, and enables the X1 and X2 markers. The data values at the X1 and X2 markers are automatically displayed to the right of the Marker field when charting label versus state. Data between the X1 and X2 markers may be rescaled. For more information on rescaling, refer to "Rescale" later in this chapter.

If a Compare Stop measurement is specified in the Stop measurement field, and the Stop measurement criteria are met, the measurement will stop even though the Markers are set to Sample. However, an X-O Stop measurement will not complete if Markers are set to Sample.

X1 and X2 Fields (Markers Sample mode only)

The X1 and X2 markers are used for displaying and rescaling specific data values. Assigning values to these fields can be accomplished in either of two ways. When the field is selected the first time, it turns light blue and rotating the knob changes the value. If the field is selected a second time, a pop-up keypad appears and becomes the entry method. The X1 field positions the green X-axis marker and the X2 field positions the yellow X-axis marker. You can zoom in on the data between the X1 and X2 markers by selecting the Rescale Field and selecting "between X axis markers." For more information on rescaling data, refer to "Rescale" later in this chapter.

Pattern

When Pattern is selected, two markers labeled X and O become available. Pattern markers identify and mark unique bit patterns in the data. Once the unique bit patterns are marked, they can be used as reference points or, when time tags are on, as criteria for a stop measurement.

Find X-pattern / Find O-pattern Field

The Find X-pattern / Find O-pattern field is a toggle field which is used to select the X or O marker for setup. The marker criteria set will be assigned to the pattern marker that is designated in this field. To assign marker criteria to the other marker, the other pattern marker must be designated in this field.

Occurrence Field

The occurrence field for both the X and O markers designates which pattern occurrence the marker is placed on. The maximum numeric value in the occurrence field is limited only by the total number of samples allowed by the memory configuration.

The occurrence field can be set in two ways. When the field is selected one time, it turns light blue and knob operation becomes the entry method. If the field is selected a second time, a pop-up keypad appears and becomes the entry method.

The reference point from which the counting of occurrences starts is either the trigger point, the start of the trace, or in the case of the O marker, the X marker.

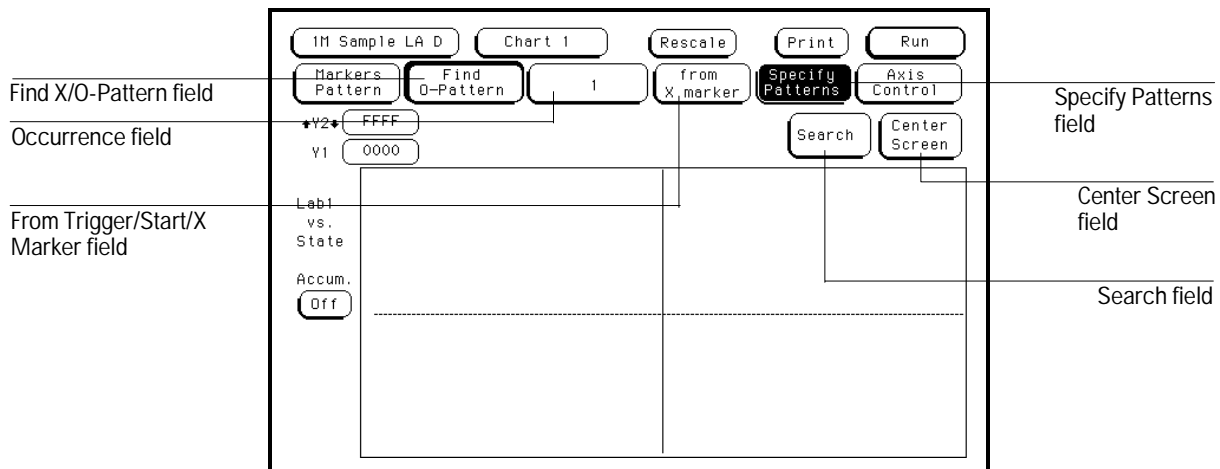

Fields Associated with Pattern Markers

From Trigger / Start / X Marker Field

The from Trigger/Start/X marker field is used to define the search start point of the X and O markers.

The start points for the green X marker are either the trace start point or the trigger point.

The start points available for the yellow O marker are either the trace start point, trigger point, or the X marker.

Search Field

The Search field initiates a search through the acquisition data for the specified occurrence of the user-defined X and O bit patterns. During the search, the Rescale field is replaced by a red Cancel field. The Cancel field stops the search. For more information on specifying bit patterns, refer to "Specify Patterns Field" section later in this chapter.

Center Screen Field

The Center Screen field is used to reposition the center of your display around the trigger, the X marker, the O marker or the X and O markers. This allows you to quickly move through the chart display to the events of interest.

Specify Patterns Field

When the Specify Patterns field is selected, a pop-up menu appears that is used to assign the bit patterns for the X and O markers and the Stop measurement criteria.

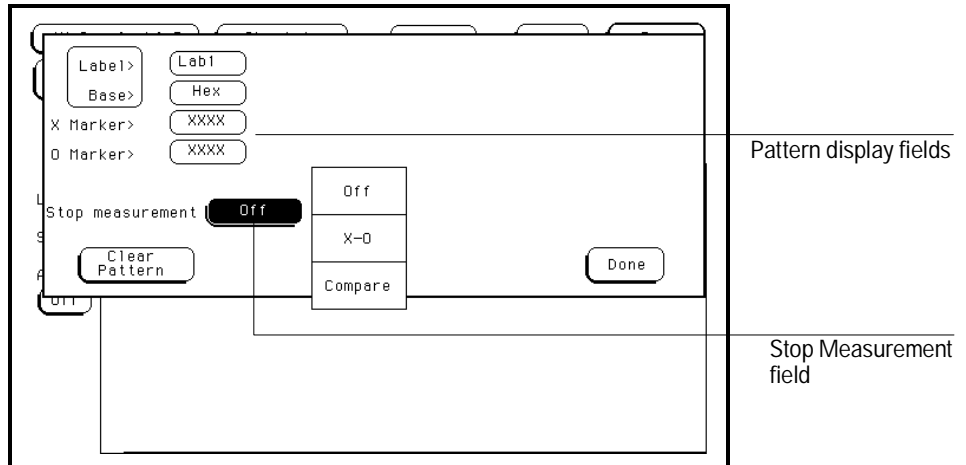

Specify Patterns Pop-up Menu with Stop Measurement Selections

Pattern Display Fields

The pattern display fields display the alphanumeric bit pattern specified for each X and O marker for all designated labels. The bit pattern is displayed in the same numeric base as in the Trigger menu. When the pattern display field is selected, a pop-up keypad appears which is used to set the bit pattern.

When there are more labels assigned than can be displayed on a single screen, the pattern display fields not shown can be rolled back onscreen by using the Label / Base roll field.

Label and Base Fields

The Label and Base fields show up together in all menus except the Format menu. When a new label is assigned, a base field is automatically assigned to that label.

Label Field Labels in the Listing menu are the same labels assigned in the Format menu. These labels will be displayed throughout the analyzer as they were assigned in the Format menu. For a complete definition of label assignment and modification, go to "Label Assignment Fields" in the Format menu chapter.

Base Field The function of the Base field is the same in most menus.

Label / Base Roll Field The function of the Label and Base roll field is the same in all menus.

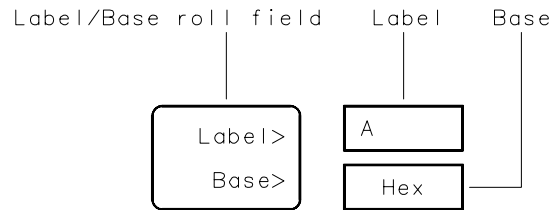

16542B03

Label / Base Roll Field

Clear Pattern

The Clear Pattern field gives you access to quickly clearing the X pattern, the O pattern, both X and O at once, or canceling your Clear Pattern request.

Stop Measurement Field

The Stop measurement function allows you to specify a condition which stops the analyzer measurement during a repetitive run.

When the Stop measurement field is selected, a Stop measurement type selection pop-up menu appears with the choices of Off, X-O, or Compare. Compare is only available if the analyzer type is State Compare. X-O is only available if Count Time is turned on in the Trigger menu.

Off

The Off selection turns off all Stop measurement operations.

If a Compare Stop measurement is specified in this field, and Stop measurement criteria are met, the measurement will stop even though the Markers are set to Sample. An X-O Stop measurement will not complete if Markers are set to Sample.

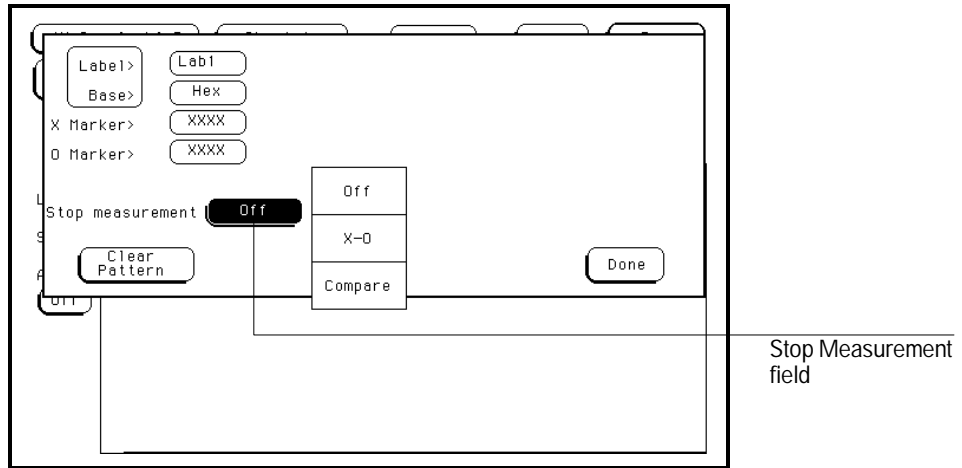

Stop Measurement Field and Pop-up Menu

X-O

X-O is only available if Count Time is set in the Trigger menu. X-O is the time between the X and O markers. During a repetitive run, X-O is compared to a selectable time value which uses one of the following four options. If a match is found, the repetitive run is terminated.

Less Than X-O time must be less than the time value that you specify in the Time field.

Greater Than X-O time must be Greater than the time value that you specify in the Time field.

In Range X-O pattern must be within the time range value that you specify in the two Time fields.

Not in Range X-O pattern must not be within the time range value that you specify in the two Time fields.

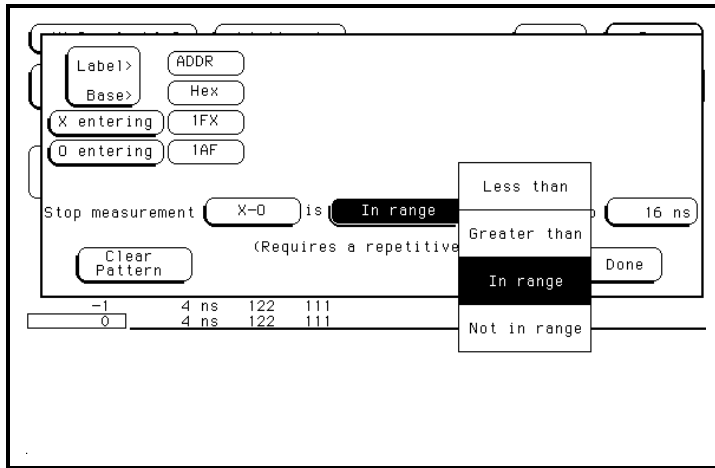

X-O Field and Pop-up Menu

Compare

Compare is only available when the analyzer type is set to State Compare in the Configuration menu. When Compare is selected, a repetitive run will be terminated when a comparison of data in the Listing menu and the data and criteria in the Reference listing matches an equality selection. The equality selection is set from the Equal/Not Equal selection pop-up menu.

Equal The data and compare criteria in the Compare menu must be equal to the data in the Listing menu.

Not Equal The data and compare criteria in the Compare menu must not be equal to the data in the Listing menu.

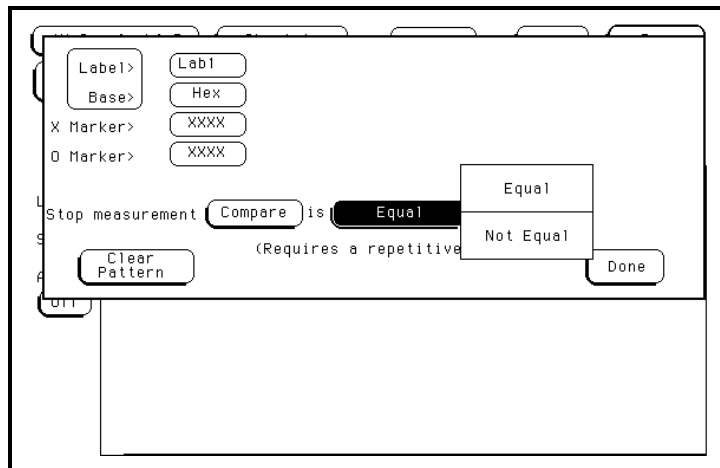

Compare Field and Pop-up Menu

Rescale

The Rescale field is used to scale the sampled states based on the position of the Y1, Y2, X1, and X2 axis markers. To zoom in on a section of the displayed chart data, position the markers around the area of interest. When the Rescale field is selected, the pop-up menu allows you to choose rescaling between the X axis markers, the Y axis markers, between X&Y axis markers, Full Scale, or Cancel.

Between X axis markers This selection will rescale data on the horizontal X axis based on the positions or settings of X1 and X2. At the end of the rescaling operation, the X1 marker will reside at the far left side of the display screen and the X2 marker will reside at the far right side of the display.

Between Y axis markers This selection will rescale data on the vertical Y axis based on Y1 and Y2 settings. At the end of the rescaling operation, the Y1 marker will be positioned at the far top of the display screen and the Y2 marker will be positioned at the far bottom of the display.

Between X&Y axis markers This selection will execute both X and Y markers operations as discussed above, resulting in the rescaling of both the horizontal and vertical axes.

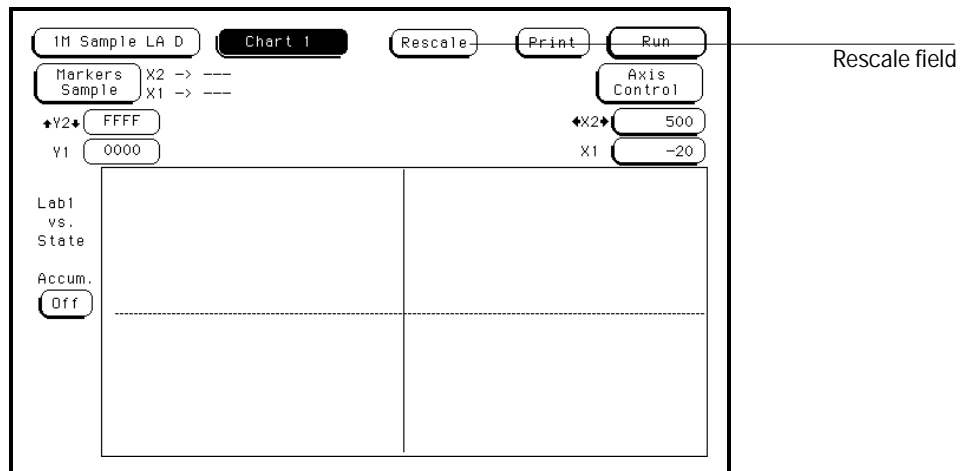

Rescale Field

Rescale

Full Scale This selection will rescale the horizontal and vertical axes so that all data samples are charted in the XY chart window. Selecting Full Scale will overwrite Y1, Y2, X1, and X2 settings, in addition to the Axis Control Ranges specified in the Axis Control pop-up menu.

Replotting Full Scale can take minutes to complete. To cancel plotting, touch the red Cancel field at the top of the display screen.

Cancel The Cancel selection allows you to exit this pop-up menu without changing the current scaling.

Axis Control Field

Touching the Axis Control field causes the Chart Axis Control pop-up menu to appear. In this menu, you specify the relation to be charted and the boundaries for the chart. The vertical Y axis will always be a label. The available labels are those which you defined in the Format menu. The horizontal X axis can be one of the same labels available for the Y axis or it can be sample memory locations.

"XY Chart of" Field (Y-axis Label)

The Y-axis label field is just to the right of "XY Chart of" text. To specify a vertical axis label, touch the Y-axis Label field, then select the desired label from the label list pop-up menu. The label choices are the labels that were defined in the state Format menu.

The values charted are the acquired data values represented by that label, in the number base selected in the Axis Control menu. The placement of the label data on the chart is determined by the scaling of the two axes. You select values for the axes scaling in the X-axis and Y-axis fields found in the Axis Control menu.

X-axis field

Y-axis field

The screenshot shows the 'Chart Axis Control' menu. At the top, it says 'XY Chart of' followed by a field containing 'Lab1', 'vs.' followed by a field containing 'Label', and another field containing 'Lab1'. Below this, 'Base:' is followed by two 'Hex' fields. Under 'X axis:', there is a 'Plot from State' field with '-20' and a 'Thru State' field with '500'. Further down, 'X max:' is followed by a 'FFFF' field, and 'X min:' is followed by a '0000' field. Under 'Y axis:', 'Y max:' is followed by a 'FFFF' field, and 'Y min:' is followed by a '0000' field. A 'Done' button is in the bottom right corner. Two lines from the left point to the 'Lab1' field (labeled 'Y-axis field') and the 'Label' field (labeled 'X-axis field').

The Axes Fields

"vs." State/Label Field (X-axis Label)

The X axis can represent a label's value or sample location. The X-axis assignment field is just to the right of "vs." text, and toggles between State and Label. To assign a sample location to the horizontal axis, set this field to State. To assign a label's value to the X axis, set this field to Label. Another field appears to the right of the Label field. Touch this field, and a pop-up menu appears showing all the labels that are defined in the Format menu. Select one of these labels to assign its value to the X axis.

An XY chart, with Y-axis data values for Lab1 of: state 0=15, state 1=16, state 2=17,...state 99=114, and X-axis data values for Lab2 of: state 0=6, state 1=7, state 2=8,...,state 99=105, would result in the chart coordinates: (6,15), (7,16), (8,17),..., (105,114). The placement of the label data on the X and Y axes is determined by the values of the Xmin, Xmax, Ymin, and Ymax fields.

X axis and Y axis Fields

Either axis of the XY chart can be scaled by using the associated vertical or horizontal min (minimum) or max (maximum) value fields. When selected, a pop-up keypad appears in which you specify the minimum and maximum values that will be displayed.

When State is selected for the X axis, sample locations are plotted on the X axis. The min and max state locations are specified in the "X axis: Plot from State" field. For State, the minimum and maximum values that are selectable depend upon the memory depth you specified in the Configuration menu. For labels, the minimum and maximum values can range from 00000000H to FFFFFFFFH regardless of axis, because labels are restricted to 32 bits.

When plotting Label versus Label, both the Y axis and the X axis can be scaled. Charted memory locations are selectable in the "Plot from State" field for the X axis.

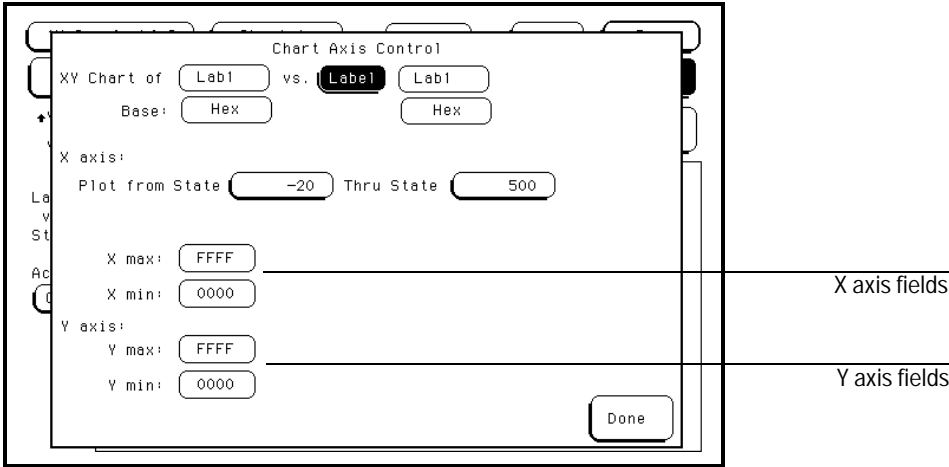

Axes Scaling Fields

Accumulate Field

The Accumulate field may be toggled between on and off. When Accumulate On is selected, data from multiple acquisitions are charted on top of one another. When Accumulate Off is selected, only the current acquisition is displayed.

Cancel Field

The red Cancel field appears while the specified chart is being plotted. It is located where the Rescale field is normally displayed. When Cancel is selected, the plotting halts, and the Cancel field disappears.

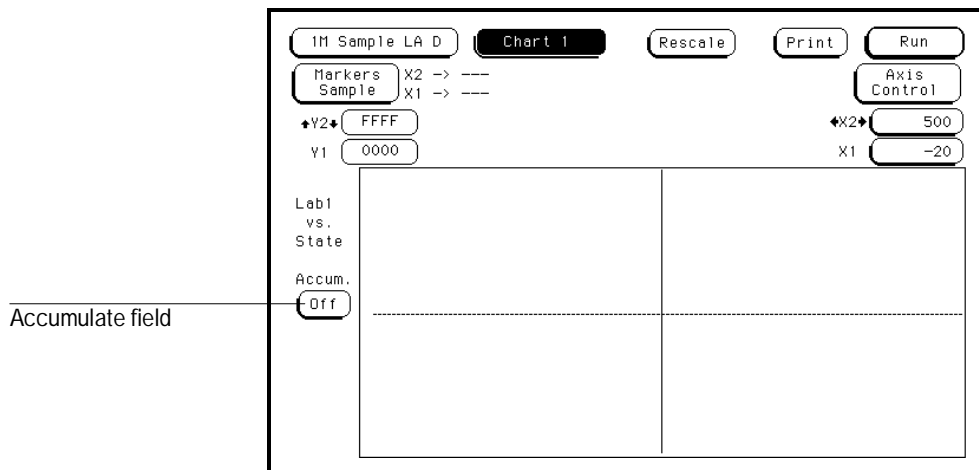

Accumulate Field



The Compare Menu

The Compare Menu

State Compare is a software post-processing feature that provides the ability to do a bit-by-bit comparison between the acquired state data listing and a reference listing.

The comparison between the acquired state listing data and the data in the reference listing is done relative to the trigger points. This means that the two data records are aligned at the trigger points and then compared bit by bit.

Any bits in the acquired data that do not match the bits in the compare image are treated as unequal.

Compare Post-Processing Features

You can view in separate listings the acquired data, your reference listing, and a listing that highlights the bits in the acquired data that do not match the corresponding bits in the reference listing.

You can edit the reference listing for unique comparisons.

You can mask specific bits that you do not want to compare. These "Don't compare" bits can be specified individually for a given label and state row, or specified by channel across all state rows.

You can select a range of states to compare. When a range is selected, only the bits in states that are on or between the specified boundaries are compared. You can save the reference listing along with the analyzer configuration to disk.



Reference Listing Field

The Reference listing and Difference listing field is a toggle field that switches the listing type between the Reference image listing and the Difference listing.

The Reference listing is a display of the image (or template) that acquired data is compared to during a comparison measurement. The boundaries of the image are controlled by using the compare range function. Any bits in the reference listing displayed as "X" have been set to don't care bits during bit editing.

See Also

"Bit Editing Field" later in this chapter for how to edit bits.

When the data listing is rolled, the difference data listing and the data listing in the Listing menu are also rolled.

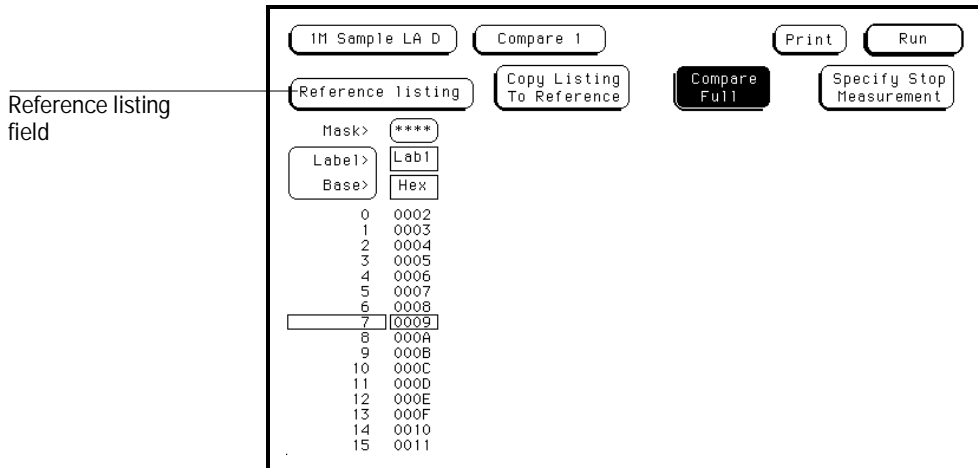

Reference Listing Field

Difference Listing Field

The Reference listing and Difference listing field is a toggle field that switches the listing type between the Reference image listing and the Difference listing.

The Difference listing is a display of the acquired data listing with the data that differs, if any, from the Reference listing, highlighted with inverse video. If the base is inverse assembled symbols, the entire line is highlighted with inverse video.

Difference listing field

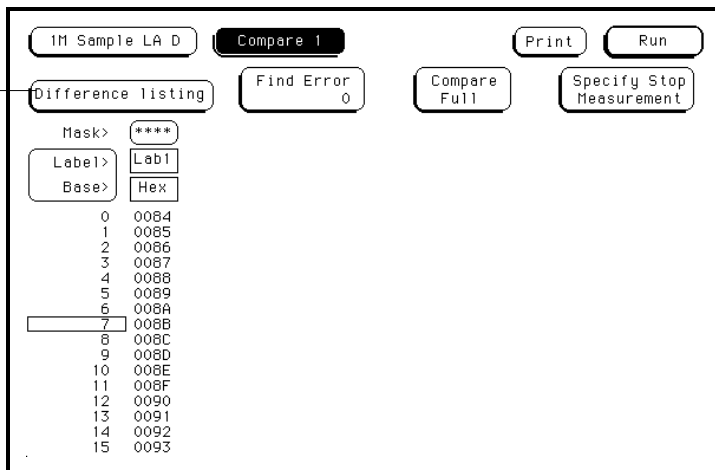

Difference Listing Field

The Compare Menu

Difference Listing Field

The controls that roll the listing in all three menus, the normal State listing, the Reference listing, and the Difference listing are synchronized unless the number of pre-trigger states differ between the Reference listing and the acquired data.

This means that when you change the current row position in the Difference listing, the analyzer automatically updates the current row in the acquired State listing, Reference listing and vice-versa.

If the three listings are synchronized and you re-acquire data, the Reference listing may have a different number of pre-trigger states depending on the state trace trigger criteria. The Reference listing can be resynchronized to the State and Difference listings by entering the desired state (acquisition memory) location from the pop-up keypad.

This allows you to view corresponding areas of all lists, to cross-check the alignment, and to analyze the bits that do not match.

Copy Listing to Reference Field

The initial Reference image is generated by either copying the data listing from the listing menu or by loading an analyzer configuration file which contains a Reference listing. You should be aware that if you load an analyzer configuration to get a Reference image, the other menu setups will change.

When the Copy Listing to Reference field is selected, the contents of the Listing menu are copied to the Reference image buffer. The previous Reference image is lost if it has not been saved to a disk.

Copy Listing To
Reference field

The screenshot shows a menu interface with several options. The 'Copy Listing To Reference' option is highlighted. Below it, a list of memory addresses and their corresponding hex values is displayed. The address 7 is highlighted in the list.

IM Sample LA D	Compare 1	Print	Run
Reference listing	Copy Listing To Reference	Compare Full	Specify Stop Measurement
Mask>	****		
Label>	Lab1		
Base>	Hex		
0	0002		
1	0003		
2	0004		
3	0005		
4	0006		
5	0007		
6	0008		
7	0009		
8	000A		
9	000B		
10	000C		
11	000D		
12	000E		
13	000F		
14	0010		
15	0011		

Copy Listing to Reference Field

Find Error Field

The Find Error field allows you to easily locate any patterns that did not match in the last comparison. Occurrences of differences, or errors, are found in numerical ascending order from the start of the listing. The first occurrence of an error has the numerical value of one.

When you select the Find Error field, the field turns light blue and the knob can be used to select a number. If the field is touched a second time, a pop-up keypad appears in which you enter a number. The number you enter indicates which error you want to find. The listing is then scanned sequentially until the specified occurrence is found and rolled into view.

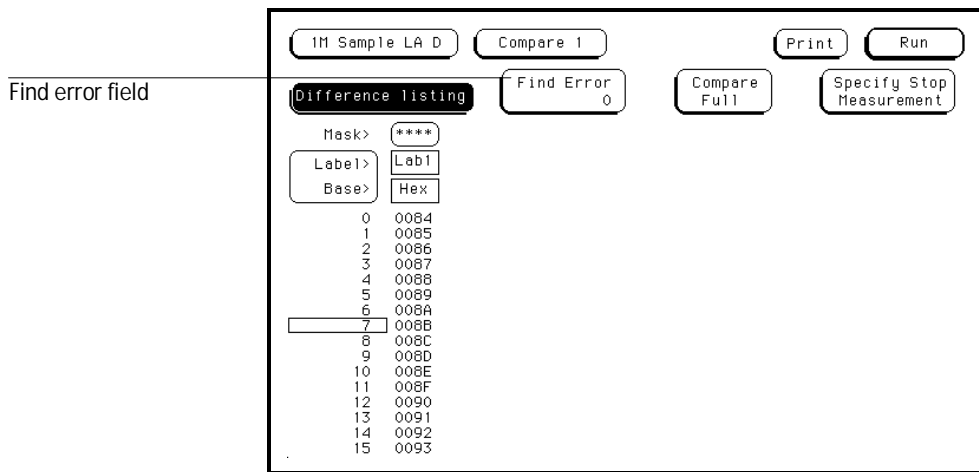

Find Error Field

Compare Full / Compare Partial Field

The Compare Full/Compare Partial field is a toggle field which allows you to compare either the full range of states or define a subset of the total number of states in the Reference image to be used in the comparison.

The Compare mode is accessed by touching the Compare Full/Compare Partial field in either the Compare or Difference listing menus. When selected, a pop-up menu appears in which you select either the Full or Partial option.

When you select the Partial option, fields appear for setting the start state and stop state values. Only bits in states (lines) on or between the boundaries are compared against the acquired data.

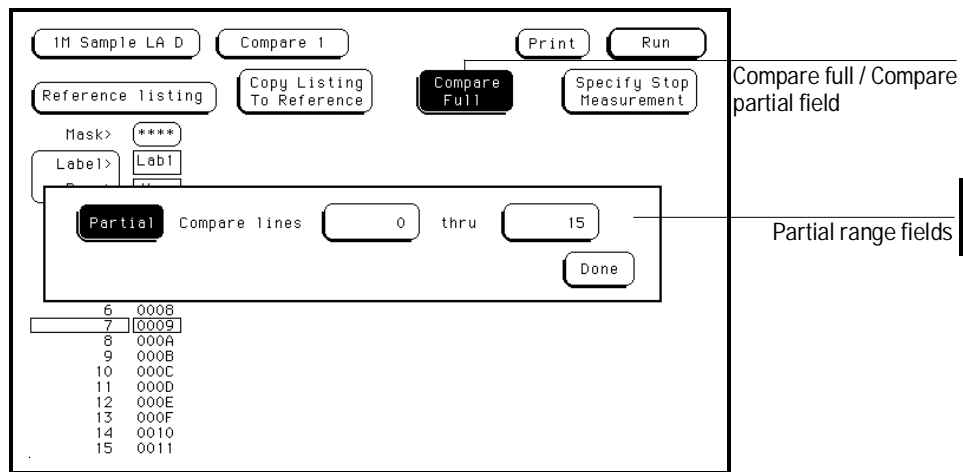

Compare Full / Compare Partial Field

Mask Field

The channel masking field is used to specify a bit, or bits in each label that you do not want compared. This causes the corresponding bits in all states to be ignored in the comparison. The Reference data image itself remains unchanged on the display.

When you select the Mask field an assignment pop-up menu appears in which you specify the channels to be compared and the channels to be masked. A period (.) indicates a don't compare mask for that channel and an asterisk (*) indicates that channel is to be compared.

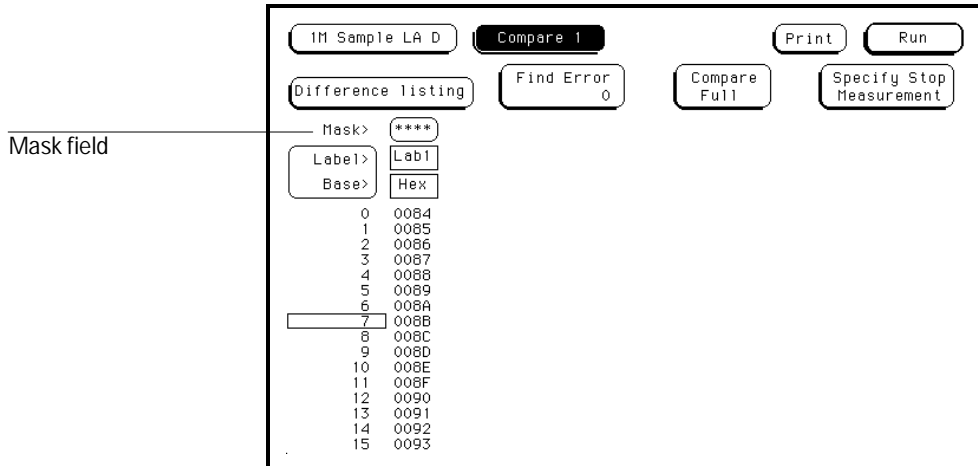

Mask Field

Specify Stop Measurement Field

The Stop measurement function allows you to specify a condition which stops the analyzer measurement during a repetitive run. When the Specify Stop Measurement field is selected, a Stop measurement menu appears which is used to set the stop criteria.

When the Stop measurement type field is selected, a selection menu appears. Depending on the analyzer configuration, you will have the choices of Off, Compare, and X-O.

Off

The Off selection turns all Stop measurement operations off.

If the stop measurement operation is not turned off and the stop measurement criteria are met, the measurement will stop even though the markers are turned off.

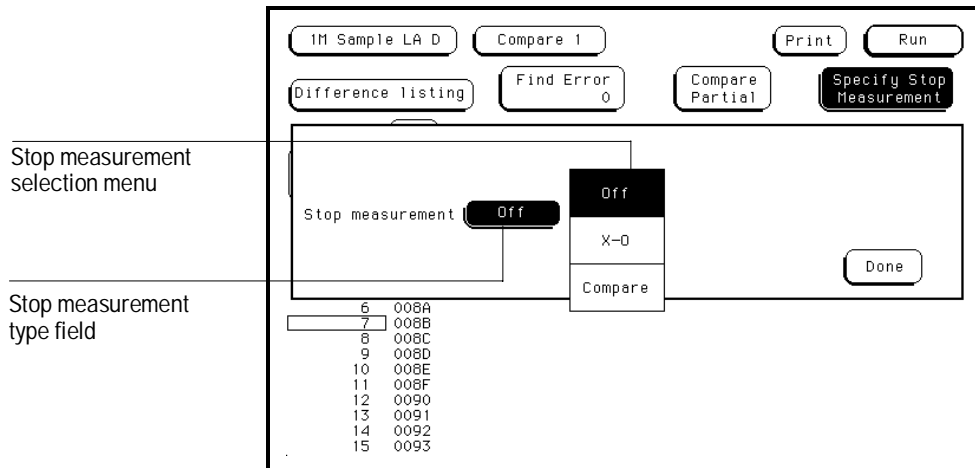

Stop Measurement Fields

The Compare Menu Specify Stop Measurement Field

Compare

When Compare is selected, a repetitive run is stopped when a comparison of data in the Listing menu and data and criteria in a Reference image matches an equality selection. The equality selection is set from the Equal/Not Equal selection pop-up menu.

Equal The data and compare criteria in the Compare menu must be equal to the data in the Listing menu.

Not Equal The data and compare criteria in the Compare menu must not be equal to the data in the Listing menu.

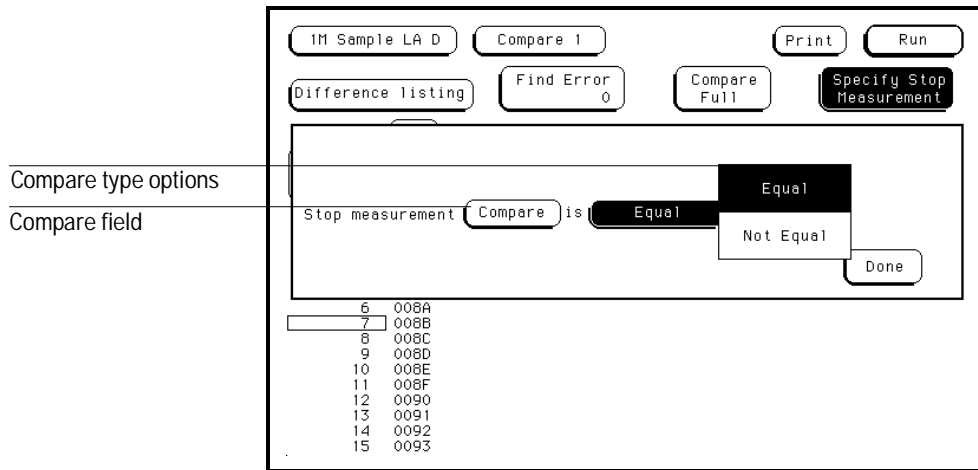

Compare Stop Measurement Type Fields

X-O

The X-O option is available in the State analyzer with its count set to Time. When X-O is selected, a repetitive run is stopped when a comparison of the time period between the X and O markers and one of the following time period options is true.

Less Than X-O time must be less than the time value that you specify in the Time field.

Greater Than X-O time must be greater than the time value that you specify in the Time field.

In Range X-O pattern must be within the time range value that you specify in the two Time fields.

Not in Range X-O pattern must not be within the time range value that you specify in the two Time fields.

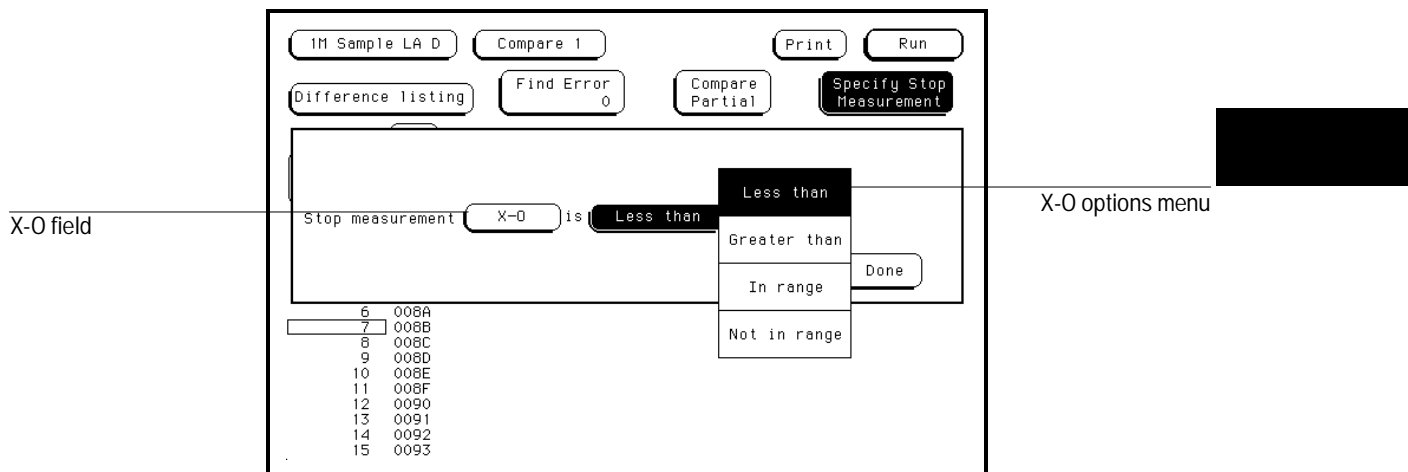

X-O Stop Measurement Type Fields

Data Roll Field

The column of numbers at the far left represents the location of the acquired data in the state analyzer's memory. The numbered positions are also known as the state locations and are relative to the trigger state location, which is always represented by 0.

The state location column, along with its data, can be rolled to display off-screen data by using the data roll field. The data roll field is the small rectangular box located in the middle of the state location column.

The data roll field is used to either roll the data listing or to select an exact state for display. When the data roll field is light blue, the knob is active and can roll data in either direction. If you touch the data roll field when it is light blue, a pop-up keypad appears for the number of an exact state. When the pop-up keypad is used, the data listing shifts, leaving the selected state in the light blue data roll box.

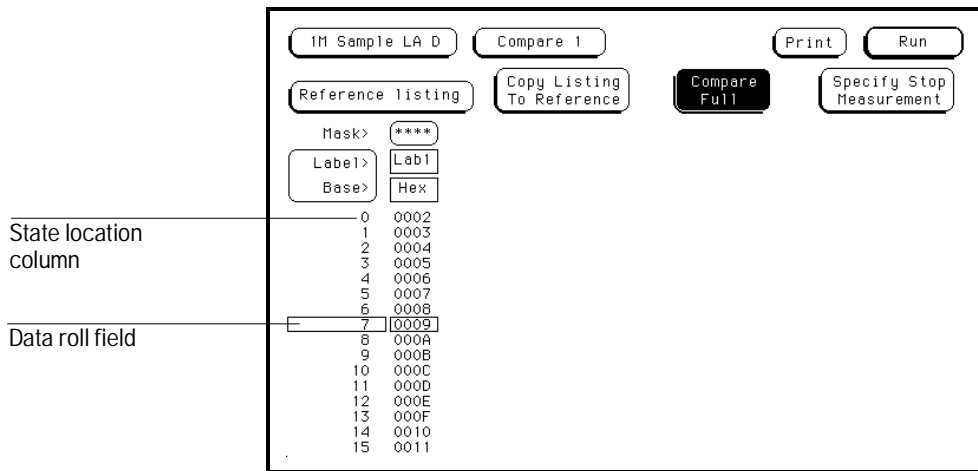

Data Roll Field

Bit Editing Field

The bit editing fields are located in the center of the Reference listing display. A bit editing field exists for every label in the display unless the label's base is ASCII or inverse assembled symbols. Bit editing field allows you to modify the values of individual bits in the Reference image or specify them as don't compare bits.

You access data in the Reference listing by rolling the data listing using the knob until the data is located in the bit editing field. To enter a desired pattern or don't compare (X) for a bit, select the field and use the pop-up keypad which appears.

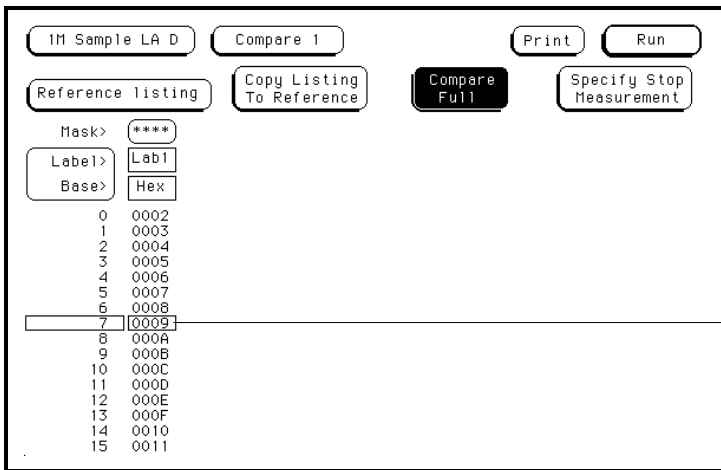

Bit editing field

Bit Editing Field

Label and Base Fields

The Label and Base fields show up together in all menus except the Format and Configuration menus. When a new label is assigned, a base field is automatically assigned to that label.

Label Field

Labels in the Compare menu are the same labels assigned in the Format menu. These labels will be displayed throughout the analyzer as they were assigned in the Format menu.

Base Field

The function of the Base field is the same in all menus. To change the numeric base, select the base field, then choose the desired base from the selection menu.

Label / Base Roll Field

The function of the Label and Base roll field is the same in all menus. The rolling function is the same for all items that are stored offscreen. For more information on rolling labels, base, and pods, refer to Labels Assignment in the "Common Module Operations" part of the *HP 16500 User's Reference Guide*.

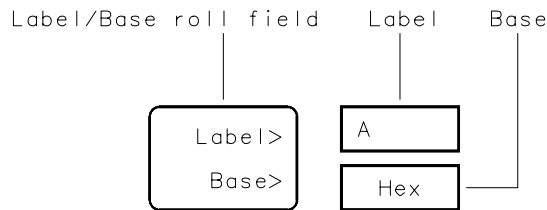

16542B03

Label / Base Roll Field



The Mixed Display Menu

The Mixed Display Menu

The Mixed Display menu allows you to view state listings at the top of the display and waveforms at the bottom.

The state listing display shows data from the state analyzer currently accessed and interleaved state listings from other modules. If the analyzer is configured with two state analyzers, both state listing displays can be interleaved as well as shown separately.

The waveform display shows timing analyzer waveforms and oscilloscope waveforms. The waveforms can be from other modules within the HP 16500 Logic Analysis System.

The Mixed Display menu is only available when the analyzer is configured as a state analyzer with the Count field set to Time in the Trigger menu. In addition, before waveforms or state listings from other modules are displayed, they must be configured in a Group Run in the Intermodule menu.

For the most part, the operation of the menu fields in the listing and waveform portions of the Mixed Display menu are identical to their operation in their respective menus. The unique functions and features of the mixed display are:

- Intermodule Configuration
- Inserting Waveforms
- Interleaving State Listings
- Time-Related Displays
- Markers

Intermodule Configuration

Before waveforms or state listings from one module are displayed in the Mixed Display menus of other modules, all modules involved in the measurement must be configured in a Group Run. The Group Run configuration takes place in the mainframe's Intermodule menu. In addition, all state analyzers must have their Count fields set to Time in their Trigger menus.

See Also

The "Intermodule Measurements" chapter in the *HP 16500B User's Reference* or "Correlating Measurements" in the *HP 16500C User's Reference* for complete information on intermodule operation.

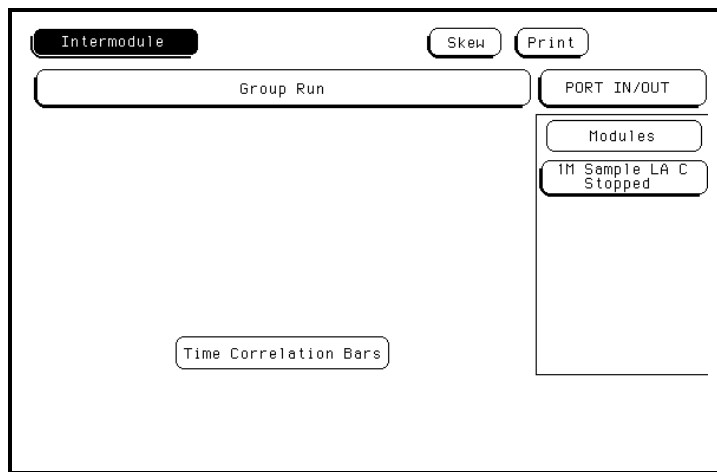

HP 16500B Intermodule Menu

Inserting Waveforms

To insert waveforms from other modules, use the same procedure for selecting waveforms as you would in the Waveform menu.

See Also

"Waveform Display" in chapter 7, "The Waveform Menu," for information on the field definitions and the waveform selection functions.

Interleaving State Listings

Interleaved state listings allows you to view two labels and their data from different analyzers in the same column. The process of interleaving state listings can be performed in either the Listing menu or the Mixed Display menu. For example, if data is interleaved in the Listing menu, it will be automatically interleaved in the Mixed Display menu.

Before a state listing from a second analyzer can be interleaved into the listing, both analyzers must be configured in a Group Run in the Intermodule menu and the Count fields set to Time in both Trigger menus.

The interleaved label is placed directly above the selected label, and all interleaved data is displayed in yellow. In addition, the state numbers of the interleaved data are indented to the right. Because of the lack of room in the listing portion of the Mixed Display menu, the label identifying the interleaved data is not displayed.

State listings from an HP 16510B, 16540A/D, 16550A, 16554A, and 16555A/D analyzers can be interleaved into the state listing of an HP 16556A or 16556D. However, the HP 16510B will not accept state listings from the other products. With one exception, the process to interleave a label is the same as inserting labels. After the Interleave option is selected, an analyzer selection is made from a list containing the analyzers configured in the Group Run. Labels for each analyzer become available when the desired analyzer is selected.

Time-Related Displays

Once the Time markers are set in the Waveform display area of the Mixed Display menu, time-related X and O Pattern markers will be displayed in both the listing and the waveform display areas.

The analyzer uses a counter to track time between the triggering of one display and the triggering of the other display. It uses this count to reconstruct time-related data.

Markers

The markers in the Mixed Display menu are not the same as in the Listing and Waveform menus. Only Time markers are available in the Mixed Display menu. Even though you have placed time markers in the listing and waveform displays, you must place new ones on your points of interest in the Mixed Display. You set the time markers in the waveform display area of the menu.





The SPA Menu

System Performance Analysis Software

The System Performance Analysis (SPA) software is included as standard software in the HP 16550 family of logic analyzers.

SPA provides you with a set of functions for performing statistical analysis on your target system. Its functions include State Overview, State Histogram, and Time Interval modes.

To be successful with this software, you should be familiar with the operation of the logic analyzer.

The screen shots shown in this chapter are HP 16550A screens. Your screens will be similar. This chapter is organized as follows:

- "What is System Performance Analysis?" outlines typical SPA applications, and describes the operating characteristics for each SPA mode.
- "Getting Started" describes how to access the SPA menus and how to select the SPA modes and set the specifications.
- "SPA Measurement Processes" is a detailed description of the measurement processes used by the SPA package. This theory of operation explains how the SPA software samples and sorts the data from the target system, and how the onscreen measurement values are computed for the State Overview, State Histogram, and Time Interval modes.
- "Using State Overview, State Histogram, and Time Interval" leads you through the three modes. It also tells how to set up SPA for the three modes, how to interpret the acquired data, and how to make measurements on specific areas of interest.
- "Using SPA with Other Features" tells you how to use SPA with other features.

Error messages and warnings used by SPA are the same as those used by the logic analyzer. Refer to "Error Messages," Chapter 12, for descriptions of these messages.

If you are just getting started, the first two sections are recommended reading. The third section is optional. If you are an experienced user, the last sections will help you with your SPA measurements. Use the first three sections for review when necessary. If you need programming information, refer to the appropriate *Programmer's Guide*, available from your HP Sales Office.



What is System Performance Analysis?

The logic analyzer's state or timing analyzer is used to make quantitative measurements on specific events in the target system. For example, a state or timing analyzer can measure a specific time interval on a microprocessor's control lines, or can find out how a particular subroutine was called.

System Performance Analysis, on the other hand, is used for qualitative measurements on the target system. SPA provides statistical analysis functions so you can determine how efficiently your target system is operating.

SPA repeatedly samples signals of interest, such as an address bus or the output of a counter. The multiple data sets from the repeated sampling are then used to build histograms and to compile statistics that describe your target system's performance over time.

Some typical examples of SPA applications include

- Obtaining an overview of system activity.
- Identifying software problems that lock up the microprocessor.
- Determining the best-case and worst-case execution times for a software module or a state machine.
- Establishing standards for software modules or state machines.
- Identifying inefficient use of mass storage and other peripherals.
- Evaluating memory utilization, such as illegal access in protected portions of memory, and locality of execution.

Operating characteristics

The following describes the operating characteristics of the System Performance Analysis software for the three SPA measurement modes.

State Overview The State Overview mode displays a bar chart of a label's state value versus the relative number of occurrences of each value in the defined range of the label. State Overview is available on any label defined in the Format Specification.

- The X axis is the defined range for the specified label divided into 256 buckets.
- The range of the specified label is user-definable.

- The Y axis is the relative number of occurrences in each bucket.
- Maximum value of the Y axis is constantly updated to reflect the number of occurrences in the bucket that has the most occurrences, and is displayed as "Max count."
- The total number of states sampled for the selected label is presented as Total count. This includes states that may be outside the user-specified X axis range.
- Two markers are available on the X axis to determine the range of a bucket and number of occurrences in any bucket.
- Choice of base for a specified label is user-definable.

State Histogram The State Histogram mode displays states that occur within user-defined ranges of a label. State Histogram is available on any label defined in the Format Specification.

- Maximum number of ranges is 11.
- Other States included/excluded is available and displays a histogram of all states not covered by the user-defined ranges.
- You can trace All States or patterned Qualified States.
- Total samples displays the total number of occurrences in all displayed ranges.
- Choice of base for specified label is user-definable.

Time Interval The Time Interval mode displays time intervals between user-defined start and end events.

- Start and end events can be defined over all labels defined in the Format Specification.
- 10 ns is the minimum sample period and time interval resolution.
- The maximum number of time interval ranges is 8.
- Time interval range size is 10 ns to 9,999,999 seconds.
- Calculated statistics provides Maximum time, Minimum time, Average time, and Total number of time intervals sampled (one time interval defined to be a paired start/end event).
- Auto-range feature automatically scales the eight time intervals over maximum and minimum times using a logarithmic scale or linear scale.
- Choice of base for labels is user-definable.

Getting Started

This section describes how to access the System Performance Analysis (SPA) menus. Also, it describes selecting the SPA modes and setting the specifications.

Accessing the menus

The SPA menus are accessed through the Configuration menu. When the configuration menu is displayed, select the Type field and choose SPA from the pop-up menu.

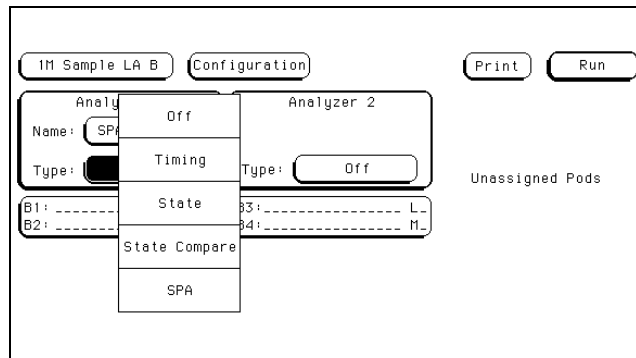

Configuring an Analyzer for SPA

Selecting State Overview, State Histogram, or Time Interval modes

To access one of the three SPA modes, select the analyzer menu field after configuring one of the analyzers as SPA and select SPA.

Once in the SPA menu, you can move from State Overview, State Histogram, or Time Interval Modes by selecting the Trace Mode field as shown in the SPA menu on the next page. A pop-up menu appears, and you can select one of the three SPA modes in the pop-up menu.

If you change modes while the logic analyzer is acquiring data, it will stop the acquisition.

Setting up the State Format specification

When a state or timing analyzer is changed to SPA, SPA will retain the state or timing format specification. For complete details on changing from a state or timing analyzer to SPA, see "Using SPA with Other Features" later in this chapter.

The State and Timing format specification menus provide symbol tables. You can use any defined symbols to specify the Low and High values in State Overview, to define the ranges and the qualified states in State Histogram, or to specify the Start and End conditions in Time Interval.

Your ability to use existing state or timing configurations with SPA depends on your application and target system. If your SPA measurement uses the same physical signals from the target system as an existing state or timing configuration, it may be easier to load the state or timing configuration from the disk instead of entering a new one.

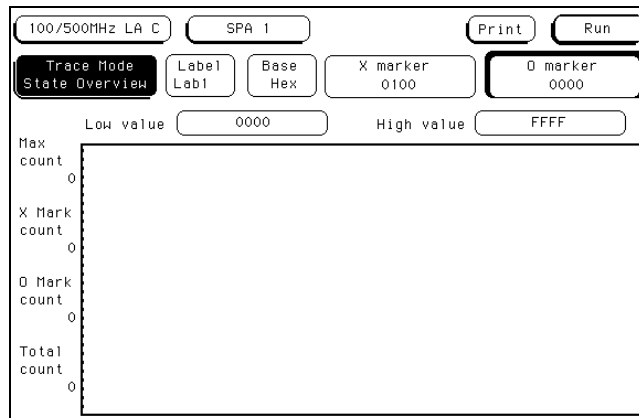

Default SPA Menu

SPA Measurement Processes

This section introduces you to the measurement processes of the System Performance Analysis (SPA) software. It tells you how to select the appropriate trace mode and labels. It also explains how SPA samples and sorts data.

Selecting and changing trace modes

SPA has three trace modes: State Overview, State Histogram, and Time Interval. These are selected by the Trace Mode field in the SPA data display.

Only the currently displayed trace mode is affected during an acquisition. While acquiring and viewing data in one trace mode, the other two trace modes are not updated. If the trace mode or any other critical variable is changed during an acquisition, the logic analyzer stops the acquisition and displays "Warning: Run HALTED due to variable change."

Each trace mode only performs statistics on its own database. Therefore, if acquisitions are completed in two different trace modes, the two modes will not contain the same data.

For example, you select the State Overview mode and press the Run key. After the data accumulates for a period, press Stop. You then select the Time Interval mode and the screen is blank since no data has been acquired in this mode. You again press Run and let data accumulate and press Stop. In this example, two separate data sets are acquired, the first for State Overview mode, the second for Time Interval. You can now move between the modes and see the correct data for the associated measurement.

This separate acquisition data applies to all three trace modes. In this way, three separate views of the target system can be acquired and stored in SPA.

Sampling methods and data sorting

SPA provides a statistical summary of target system behavior over time. The greater the number of samples, the more accurate the statistics. Therefore, SPA should always be run in the Repetitive mode. By doing this, the analyzer will continue to sample the data and update the display until Stop is pressed, or until a sampling variable is changed on the display.

After SPA completes an acquisition, each sample in the current acquisition is compared to the ranges or buckets for the current trace mode. If the sample matches a range or bucket, it is sorted into that range or bucket. This process is repeated for every sample in the acquisition. After the entire acquisition

has been sorted, the histograms and displayed statistics are updated, and the analyzer is re-armed for the next acquisition.

Refer to the following sections on the three trace modes for details on sorting criteria and statistical computation.

Between each successive acquisition, there is blind time during which the captured data is unloaded and sorted, the display is updated, and the analyzer is restarted. The length of the blind time is a function of the complexity of the SPA measurement.

Selecting and changing labels

A label in Hewlett-Packard logic analyzers is defined in the Format menu. A label is any named group of 32 or fewer data channels.

The State Overview and State Histogram modes monitor one label at a time. Any labels that are defined in the Format menu are available. A typical example is the ADDR (address) label used in many of the Hewlett-Packard inverse assembler configurations. Often, SPA measurements will use the ADDR label to monitor memory activity.

Qualified State Histogram and Time Interval modes use all of the labels in the Format menu to define either the qualified state or the start and stop events, respectively. State Overview and State Histogram deal with recorded states, and Time Interval deals with time.

Changing from one label to another in State Overview or State Histogram mode or changing the Start or End pattern in Time Interval erases any configuration and data for the original label. When returning to the original label, the display returns to its default mode. Loss of configurations and data when changing between labels can be prevented by saving configurations of interest to the disk before making the change, or by printing the results.

State Overview mode

State Overview mode is an X-versus-Y chart of the activity on a specified label. It provides a global view of the distribution of activity of the target system signals grouped under the specified label.

X axis scaling The X axis represents the defined range of the specified label and is divided into a series of buckets, or smaller ranges. The range of the X axis is defined by the Low value and High value fields, and is

divided equally among 256 buckets. For example, if the range defined by the low and high values is 1100, then 1100 divided by 256 equals 4.29. This value will be rounded up to 5, each bucket will have a range of 5, and only 220 buckets will be used ($1100/5 = 220$). The display grid will be truncated on the right because only 220 buckets are displayed.

If the full range of the label or the portion of the label defined by the Low value and High value is less than 255, then the number of buckets will be the difference between the Low and High values.

The Low and High values can be specified as discrete values in binary, octal, decimal, or hexadecimal. If Symbols have been defined in the Format menu, they can also be used for the low and high values.

Data sampling and sorting When Run is pressed, all input channels defined in the Format menu are sampled. Once acquired, the sampled data is sorted into the buckets of the specified label, and the State Overview display is updated. The acquisition is repeated until Stop is pressed or until a display variable is changed.

Y axis scaling The display builds a vertical histogram where the Y axis represents the relative number of occurrences in each of the buckets. As successive acquisitions are acquired and sorted, the display is constantly re-scaled vertically so that the upper limit of the Y axis represents the largest number of occurrences in any bucket.

The Y axis maximum limit is displayed in Max count.

Total count The Total count field is the total number of states sampled over the entire label range since the measurement was started.

X and O markers Markers can be placed on any bucket to determine the number of occurrences in that bucket. The X Mark count and O Mark count fields display the number of occurrences at the markers. The markers move only on the bucket boundaries.

The range of each bucket can be determined by selecting the X marker or O marker fields and noting the change in the marker value in the pop-up as the marker is moved slowly across the display.

Example

An example of a State Overview measurement is testing for access to a reserved area of memory. In this case, the channels of the address bus of the target system would need to be grouped under a single label, such as ADDR. By selecting the ADDR label in State Overview mode, and by defining the full range of the label (Low value = 0000, High value = FFFF with a 16-bit ADDR label), activity over the entire address range can be monitored. Access into reserved memory is easily identified.

By selecting only the range of the reserved area of memory with the Low and High values, the number of address values per bucket is decreased and a more detailed analysis can be performed.

The figure below shows a State Overview display.

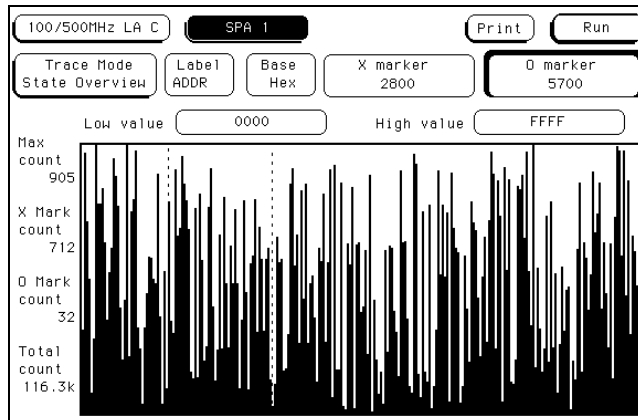

SPA State Overview Menu

State Histogram mode

State Histogram mode displays relative activity of ranges of a specified label. The ranges can also be compared to activity on the rest of the label not defined in the ranges. Data qualification is possible with State Histogram, so data can be filtered during acquisition.

Data sampling and sorting When Run is pressed, all input channels defined in the Format menu are sampled. Once acquired, each sample in the acquisition is compared to each defined range. If the sample value is inclusively within the range and if the range is on, the count for that range is incremented, then the State Histogram display is updated. The acquisition is repeated until Stop is pressed or until a display variable is changed.

The histogram is displayed on a percentage scale, and each bar represents the fraction of all samples in that range. For example, if a bar reaches the 40% value on the display, then the range for that bar contains 40% of all the samples displayed. If the total of all bars equals greater than 100%, then ranges have been overlapped and data has been counted twice.

State Histogram vs. State Overview State Histogram is similar to State Overview, but there are key differences between the two modes. State Overview shows relative distribution of activity over a single contiguous range of a label. State Histogram also allows several non-contiguous ranges of a label to be defined.

State Overview requires minimal setup, and provides a quick overview of system activity. State Histogram requires more setup, but provides greater resolution and measurement flexibility.

State Overview mode does not display data that falls out of the range of its Low and High values. State Histogram, on the other hand, has an "Other States included/excluded" feature that will present a histogram of any activity that does not fall into the defined ranges (see "Other States included/excluded," later in this section).

State Overview samples and displays all activity on the specified label. But State Histogram allows data qualification so that only activity of interest is sampled and displayed (see "Trace Type: All States vs. Qualified States," later in this section).

Range specifiers Up to 11 ranges are available. The ranges are defined by specifying a low and high value on the specified label and by a name you define. The ranges need not be contiguous. If two ranges overlap in any manner, acquired data will be counted in both ranges.

If a range has a low and high value and a name defined, and the range is turned off, it will retain the low and high value and name when turned back on.

User-defined ranges vs. symbols When defining low and high values for the State Histogram ranges, you may use symbols instead of entering discrete values. Symbols can only be used for labels selected in the State Histogram mode if they are defined in the Format menu, and only if the base in the State Histogram menu is set to Symbol.

Pattern or range symbols defined in the Format menu can be used to set the low or high value of a range.

Total samples The total samples field displays the total number of samples in all the displayed ranges. If Other States included is selected, then total samples is the total of all displayed samples plus the other states. If any ranges are overlapped and samples fall in multiple buckets, these samples are only counted once in total samples.

Number of samples per range Displayed next to each bar is a value representing the number of samples for that range. The ratio of these values to total samples determines the relative size of the histograms. These values are updated as the repeated acquisitions are sorted and displayed.

Other States included/excluded Usually the defined ranges will not cover the entire range of the specified label. The Other States included/excluded field provides an optional histogram showing all activity on the specified label that does not fall within any of the defined ranges. By selecting excluded, the relative activity of only the defined ranges is displayed. If included is selected, the "other" histogram appears under the ranges.

If a range is turned off, any activity in that range is included in Other States. The activity of a turned off range is included in the other range whether included or excluded other states is displayed or not.

Trace Type: All States vs. Qualified States State Histogram mode can qualify data as it is sampled. Qualifying data while sampling allows only data of interest to be stored, while the rest is thrown away.

When Trace Type is set to Qualified States, a new field appears in the upper row of the display. The new field, Specify States, is where the data qualification is defined. The data qualification is not limited only to the label selected in the State Histogram menu. It is defined over all labels defined in



the Format menu as a combination of values, in the current base, and don't cares.

For example, a microprocessor target system memory may contain two arrays. In State Histogram, the address ranges of the arrays can be defined and the relative activity in the arrays monitored. But, what if you only want to monitor writes to the array? In this case, you can define the data qualification as "Memory Write" on the STATUS label.

States that do not meet the qualification criteria are not stored by the analyzer, so they are not included in Other States.

Example

A computer system has several I/O devices, such as a data terminal, disk drive, tape drive, and printer. Each device has its own service routines stored in memory. The problem is that one or more of the devices is tying up the CPU.

The system address bus is monitored using State Histogram to define the memory blocks where the service routines are stored. The histograms quickly show that the print spooler is not working because the printer is constantly interrupting the CPU and is consuming 80% of address bus activity.

The figure below shows a sample State Histogram display.

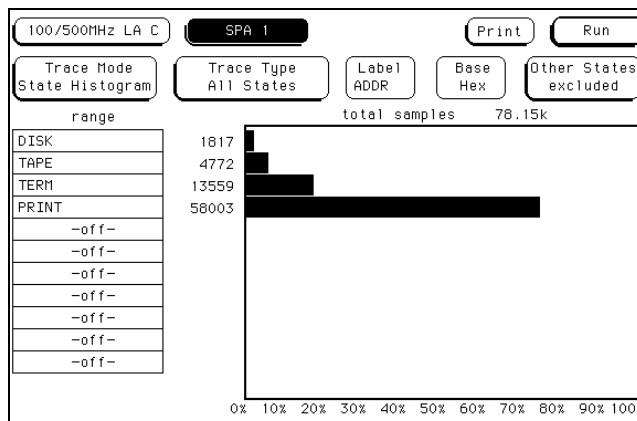

SPA State Histogram Menu

Time Interval mode

Time Interval mode shows distribution of execution time of a single event. The event is defined by specifying Start and End conditions as patterns across all labels defined in the Format menu.

Data sampling and sorting When you press Run, the analyzer samples the target system using the definitions entered in the Format menu. During acquisition, the state analyzer searches the data for the start and end conditions, and uses the analyzer's time tag feature to time the event. The time durations for each Start/End pair are then sorted into user-definable time interval ranges on the display. The acquisition is repeated until Stop is pressed or until a display variable is changed.

After the data is sampled, timed, and sorted, the histogram for each time interval range is updated.

If two time intervals are adjacent and have a common boundary (the upper limit of one equals the lower limit of the next), and a sampled time interval falls on the common boundary, the sample will be sorted into the higher time interval.

Start/End conditions Start and end conditions for Time Interval are specified on all labels defined in the Format menu as a combination of values in the current base and don't cares.

If a start or end condition is not found during an acquisition, the histogram will not change. The analyzer will only update when a start and stop event are both found.

Start and end conditions need not be adjacent in the data stream. For example, when the state analyzer sees the specified start condition, it starts the timer. If the start condition occurs again before the end condition occurs, the timer will not be reset.

For measurement purposes, the analyzer measures the time between the first occurrence of the start condition and the first occurrence of the stop condition.



Time Interval ranges Up to 8 time interval ranges are available. Each range has a lower and upper limit which can be entered manually. The Auto-range feature will automatically scale the eight ranges. The minimum allowable limit is 0 ns, the maximum 9,999,999 seconds.

Ranges do not have to be contiguous. However, gaps between ranges increase the risk of missed data. If two ranges overlap, data will be counted in both ranges. This applies to any number of overlapping ranges, or any portions of overlapping ranges. Common boundaries of adjacent ranges are not considered to be overlapped.

A range can be turned off by setting the lower and upper values to zero.

Auto-range The Time Interval ranges can be scaled quickly by selecting "Auto-range." This option requires a global Minimum time and Maximum time for the eight time interval ranges. The eight ranges are then scaled using either a log scale or linear scale.

All the ranges may be quickly initialized to off by selecting Auto-range, setting Minimum time and Maximum time to zero, and performing a linear scale.

The smallest increment allowable using Auto-scale is 10 ns. If the time interval defined by the minimum and maximum times is too small to allow all 8 ranges to be scaled, Auto-range will scale as many as possible and exclude some upper time interval ranges. The maximum resolution of each time interval is 10 ns.

Min, Max, and Avg Time Statistics The Time Interval mode display shows three statistics: Maximum (Max) time, Minimum (Min) time, and Average (Avg) time. These values are displayed whether or not they fall into any of the time interval ranges. Therefore, they are helpful in determining if the appropriate time intervals have been chosen.

The maximum resolution of the statistics is 8 ns.

Total samples Total samples is displayed above the histogram. A sample is defined as one Start/End pair. The Total samples field is not updated until the analyzer's memory is full or until Stop is pressed.

Example

A team of applications programmers is writing a math package for a spreadsheet. They need to develop standards for the various math functions. Using time interval mode, they can test the execution time of each of the math functions.

For each math function, they enter the starting and ending addresses in the Time Interval menu. They run the math function while monitoring its execution time with their logic analyzer in the Time Interval mode. Using Auto-range, they can quickly vary the time interval ranges for either greater time coverage or greater time resolution.

If the programmers wanted to see the details of the time intervals, they could set up a state analyzer measurement (not using SPA) and capture the activity between the start and stop events. The details could then be viewed in the state listing menu.

The figure below shows a sample Time Interval menu and its display.

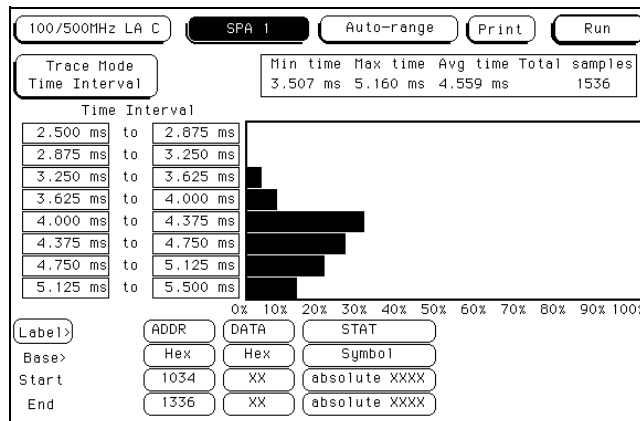

SPA Time Interval Menu

Measurement example using all three trace modes

In a 32-bit microprocessor system, you want to determine how efficiently the CPU is being utilized. Critical questions might be: are any processes consuming excessive processing time, are any processes getting stuck in wait loops, and is the system handling service calls and interrupts efficiently?

You connect the HP logic analyzer to the address bus of your system. In the Format menu, you define a 32-bit label called ADDR and the state clocking. In many cases, HP provides preprocessors, inverse assemblers and standard configurations for popular microprocessors, and you need not enter the configuration manually or worry about probing issues.

In the State Overview mode, you select the ADDR label and start the acquisition to monitor the entire memory space. After several acquisitions, five areas of relatively high activity begin to build on the histogram. Using the X and O markers to determine the address boundaries of these five regions, you quickly recognize two programs, a delay routine in the operating system kernel, and a keyboard interrupt routine. The figure below shows the State Overview display.

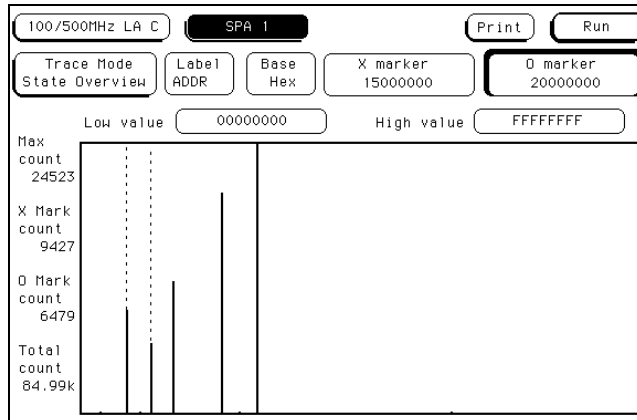

SPA State Overview

Next, you go to the State Histogram menu and enter the names and boundaries of the five routines in the state histogram ranges.

State Histogram then displays the relative activity of the five routines. After several acquisitions, it is apparent that the interrupt routine is being accessed more often than expected.

The figure below shows the State Histogram display for this example.

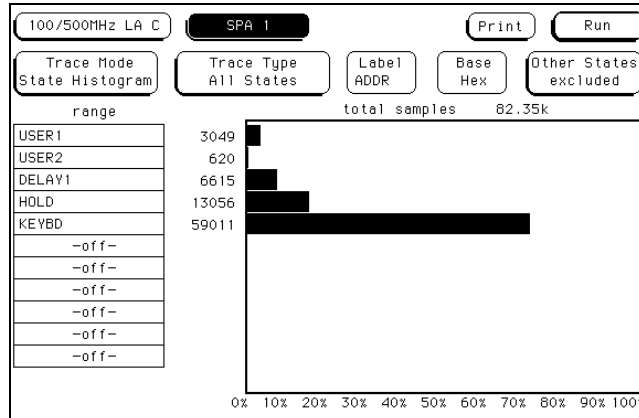

SPA State Histogram

You now go to the Time Interval menu and enter the Start and End conditions for the suspect interrupt routine. Before altering the default Time Interval ranges, you start the acquisition and observe the Maximum (Max), Minimum (Min), and Average (Avg) times. From these values, the typical execution times of the interrupt are apparent, and provide good starting values for the Time Interval ranges using Auto-range. From the Max time, it is apparent that the interrupt routine is having problems.

Running the acquisition again, you discover that the interrupt usually takes the expected 8 microseconds, but occasionally it takes as long as 8 milliseconds. After experimenting with the target system while monitoring the interrupt with Time Interval mode, a faulty key on the keyboard is discovered. The key is bouncing excessively, resulting in an extended interrupt routine call.

The figure on the next page shows the Time Interval display for this example.

The SPA Menu
SPA Measurement Processes

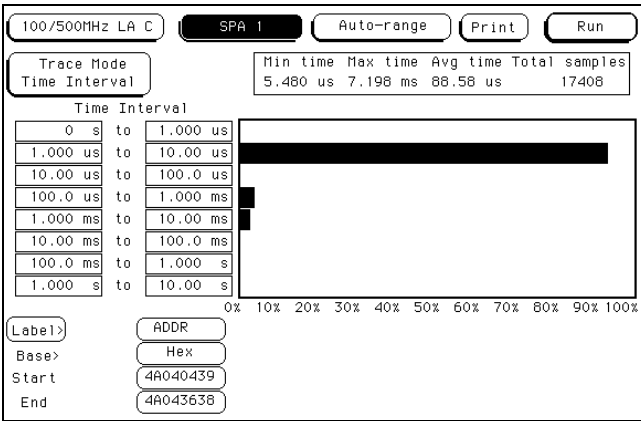

SPA Time Interval

Using State Overview, State Histogram, and Time Interval

This section explains how to select the display fields, set up the logic analyzer and use the State Overview, State Histogram and Time Interval modes of SPA.

Setting up the logic analyzer

This section assumes you have defined the format and have connected the logic analyzer probes to the target system. For complete details on these topics, refer to the appropriate reference section.

For a detailed description of State Overview, State Histogram, and Time Interval mode measurement processes, refer to the third section, "SPA Measurement Processes."

Using State Overview mode

Choosing a label to monitor To specify a label to monitor, select the "Label" field in the State Overview menu (item 1 in the figure on the next page). The pop-up shows a list of all the labels defined in the Format menu. From this list, choose the label you want to monitor.

Changing from one label to another will erase the display setup for the first label. If you want to change to a different label, but don't want to lose the setup for the current one, first save the current one to disk or print it.

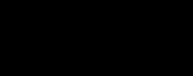

The SPA Menu Using State Overview, State Histogram, and Time Interval

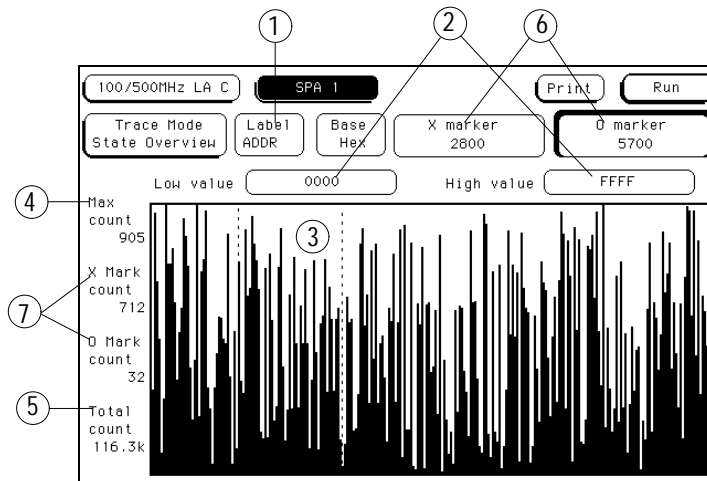

SPA State Overview menu with fields called out

Specifying Low and High values The range of the X axis is determined by the Low value and High value fields (item 2 in figure above). To change the X axis range, select the Low value or High value fields and enter new limits. The range you specified will then be divided among the 256 available buckets along the X axis (unless the range is less than 256 or the histogram frame is truncated due to bucket range round-off).

For example, you might set the low and high values so that the range is 1100. 1100 divided by 256 is 4.29. This will be rounded up to 5, and each bucket will have a range of 5. Since 1100 divided by 5 is 220, the histogram frame will be truncated at the right because the X axis will have only 220 of the 256 buckets.

The default high and low values represent the full range of the label you chose. Before changing these values, you may want to run the acquisition and acquire some data to view activity over the entire range of the label. You can then zoom in on areas of interest.

You can enter low and high values in binary, octal, decimal, hexadecimal, ASCII, or symbol.

Interpreting the histogram display Select Run Repetitive to start the State Overview acquisition. As the data is sampled and sorted, the buckets along the X axis will accumulate (item 3 in the figure on the previous page). The relative size of the vertical bars show the distribution of activity on the label you chose. The analyzer will continue to sample, sort the data, and update the display until you press Stop or until you change a display variable.

Max count (item 4 in the figure on the previous page) represents the current upper limit of the Y axis for the bucket with the greatest number of data samples. Max count for the limit of the Y axis will increase as the buckets fill with samples.

Read Total count (item 5 in the figure on the previous page) to find the total number of samples taken over the specified range of the label. This is not affected by the low and high values.

Using the markers To find the number of data samples in any bucket, select the X marker or O marker field (item 6 in the figure on the previous page). Turn the knob to move the marker to the area of interest. Read the X Mark count or O Mark count values to determine the number of samples in the current bucket (item 7 in the figure on the previous page).

As you move either marker across the display, the value in the X Marker or O Marker pop-up will change. The amount of change of the marker's value represents the size of the bucket.

Zooming in on an area of interest When viewing the State Overview display, you may see areas of high activity and areas of little or no activity. To zoom in on one of these areas for more resolution, put the X and O markers on the boundaries of the area, then adjust the low and high values to match the X and O marker positions.



Using State Histogram mode

Choosing a label to monitor To specify a label to monitor, select the Label field in the State Histogram display (item 1 in the figure below). In the pop-up, you will see a list of all the labels defined in the Format menu. From this list, choose the label you want to monitor.

Changing from one label to another will erase the display setup for the first label. If you want to change to a different label, but do not want to lose the setup for the current one, save the current one to a disk.

Defining the ranges To define a range on the specified label, select one of the 11 range fields (item 2 in the figure below). When you select one of the 11 ranges, you will see the Range Definition pop-up (item 3 in the figure below). This pop-up has fields where you enter the low and high value, a name for the range, and whether the range is on or off.

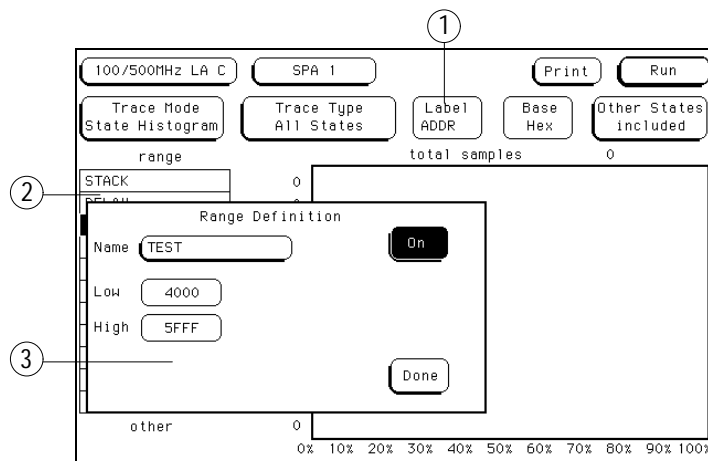

SPA State Histogram Menu with Fields Called Out

Using symbols for ranges In the Format menu, you can define symbols for any available label. The symbols can be defined as Pattern Symbols or as Range Symbols. For complete information on defining and using symbols, see "Symbols Field" in chapter 4, "The Format Menu."

If you set the base field in the State Histogram display to Symbol, you can use any defined range or pattern symbol to set the lower and upper values of the ranges.

Tracing All States vs. Qualified States You can qualify the data sampled and sorted in the State Histogram by selecting the Trace Type field and setting it to Qualified States (item 1 in the figure below). This creates a new field at the top of the display called "Specify States."

Select Specify States (item 2 in the figure below) and you will see a pop-up that contains a pattern field for every label defined in the Format menu. Use the pattern fields to define the data qualification.

For example, in the State Histogram you may want to monitor the address bus of a microprocessor system to examine memory activity. But, you may want to monitor only writes to memory. In the Specify States pop-up, you can tell the analyzer to sample only memory writes by entering under the STATUS label the bit pattern or symbol that corresponds to memory writes.

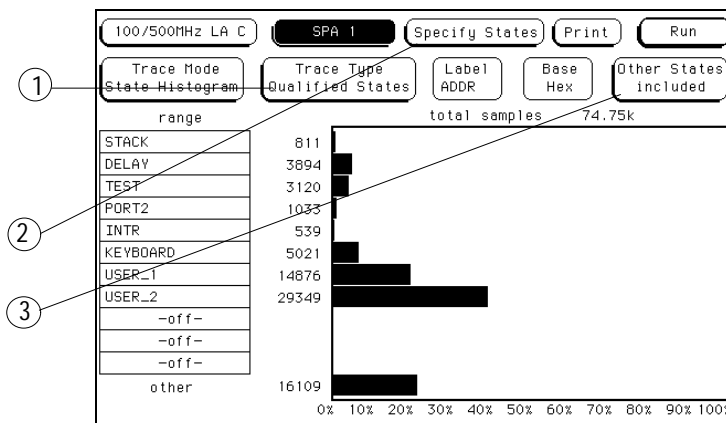

SPA State Histogram menu with fields called out

Interpreting the histogram display Select Run Repetitive to start the State Histogram acquisition. The relative activity over the ranges you defined is displayed as histograms (see the figure on the previous page). The total samples field shows the total number of data samples displayed in all of the ranges. The number of samples for each range is displayed to the left of each histogram.

The percentage amounts of the histograms total 100% (note the scale at the bottom of the display). If they add up to more than 100%, you have overlapped two or more ranges, and the data samples are being counted in multiple ranges.

The analyzer will continue to sample, sort the data, and update the display until you press Stop or until you change a display variable.

Other States included/excluded The histograms show the relative distribution of activity over the ranges you have defined. In most cases, the ranges will not cover the full range of the label you chose to monitor.

To view the activity over the entire range of the label, including activity not covered by the ranges, select the Other States field and change it to included (item 3 in the figure on the previous page). Another histogram bar called "other" will appear at the bottom of the display. This will show activity not covered by the ranges. You can toggle included/excluded if the analyzer is running since it only affects the display and not the accumulated data that has been acquired.

Note that changing between included and excluded changes the absolute sizes of the histograms. Unless you have defined overlapping ranges, the total percentage size of the all the range histograms plus the histogram for other should equal 100%.

Using Time Interval mode

Use Time Interval mode to determine the distribution of time between two specific events. The state analyzer uses the time tag feature to time the event; thus, in Time Interval mode, the minimum state clock period is 10 ns.

Specifying an event To use Time Interval mode, you must define an event that you want timed. At the bottom of the display, note the Start and End fields (item 1 in figure below). To define an event, select the appropriate labels in the Start and End fields to define the boundaries.

For example, start and end might be the beginning and ending addresses of a subroutine stored in memory. If you are timing a counter period, start and end might be the initial and final count values.

Note that in start and end, you are not limited to a single label. You define the event over all available labels as patterns including don't cares. Be sure that the start and end conditions actually occur in the target system or the analyzer will not find the timing reference points and will not make the time interval measurement. You may want to use the state analyzer (not SPA) to verify that the Start and Stop events actually occur.

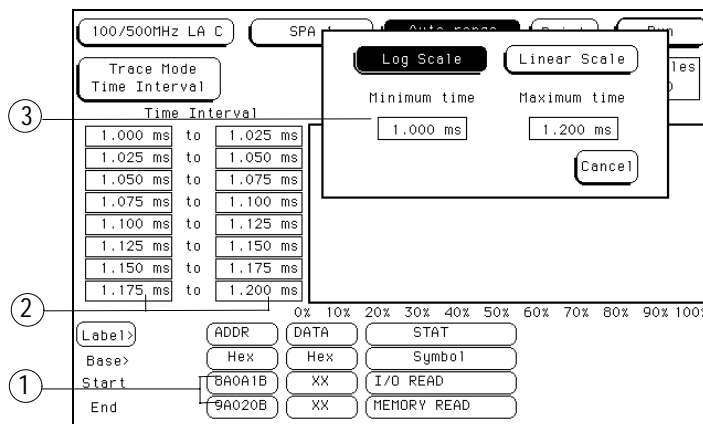

SPA Time Interval Menu with Fields Called Out

For measurement purposes, the analyzer measures the time between the first occurrence of the Start condition and the first occurrence of the Stop condition.

Defining the Time Interval ranges Before changing the ranges from their default values, you may want to press Run and acquire some data. From this initial run, the Maximum (Max), Minimum (Min), and Average (Avg) statistics on the display will help you choose the appropriate set of Time Interval ranges.

To define the ranges, select the fields for the lower and upper limits (item 2 in the figure on the previous page) and enter the limits of the range. The ranges do not need to be contiguous, but if you leave gaps between the ranges, critical data may be missed. Also, if you overlap ranges, data may be counted multiple times and present a misleading histogram.

Using Auto-range To quickly set up all 8 time interval ranges, select the Auto-range field. Enter the minimum time and maximum time for all 8 ranges combined. Then, when you select Log Scale or Linear Scale, all 8 ranges will be scaled accordingly between the Minimum and Maximum times. See item 3 in the figure on the previous page for the Auto-range pop-up. Common boundaries of adjacent ranges are not considered overlapped. Values that fall on the common boundary will be included in the highest range.

A fast way to set up the Time Interval display is to define your Start and End events and select Run using the default ranges. Select Repetitive Run mode. After accumulating data for a while, press Stop. Then select Auto-range and enter the Min time and Max time display statistics in the Auto-range Minimum time and Maximum time fields. When you select Log Scale or Linear Scale, the ranges will be defined automatically.

Interpreting the histogram display As the analyzer samples the data, it searches for Start/End event pairs. One event pair is considered one sample. The time value for each event pair is compared to each defined time interval range. The range's count is incremented if the time value falls within that range.

The analyzer continues to search for Start/End event pairs until you press Stop or until you change a display variable. The distribution of the events' time duration is displayed as histograms (see figure below).

The Max time, Min time, and Avg time statistics give you useful statistics for the event you defined no matter what ranges you've set up (item 1 in figure below).

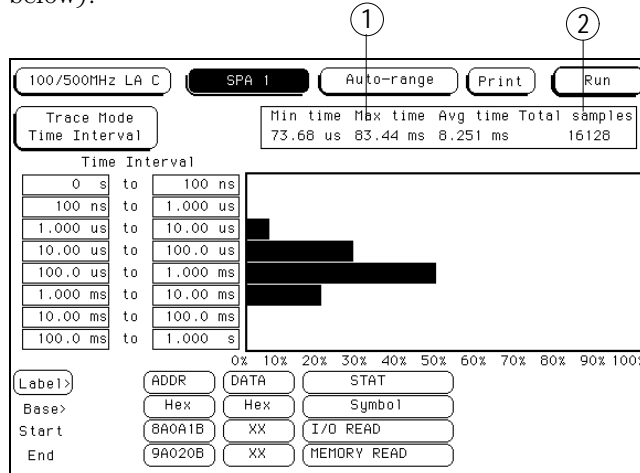

SPA Time Interval Menu with Statistics Called Out

The Total samples field shows the number of Start/End event pairs found by the analyzer, whether they are covered by the ranges or not (item 2 in figure above).



Using SPA with other features

Programming with SPA

SPA is programmable. Refer to the appropriate *Programmer's Guide* for SPA commands. The *Programmer's Guide* is available as an option with the logic analyzer. Contact your HP Sales Office for more information.

Changing between SPA and a State/Timing Analyzer

If you have configured a state or timing analyzer in the logic analyzer, you can quickly change to SPA, or from SPA to a state or timing analyzer. You can use the same Format menu in your SPA measurements as you did in your state or timing analysis measurements.

To change between a state analyzer and SPA, go to the Configuration menu, select the Type field, and select SPA from the list.

When SPA is selected, a separate trace specification definition is used. Even though the Qualified State Histogram and Time Interval modes use the same pattern recognizers as the state and timing analyzers, the SPA definitions are kept separate from those entered in the state or timing analyzer mode. As a result, switching between SPA and state or timing recovers the user's original pattern recognizers for the selected mode.

Any Symbols in the Format menu will also carry over to SPA.

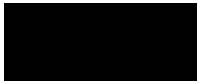

Error Messages

About Messages

This chapter lists the error, warning, and advisory messages that you may encounter during operation of the analyzer. Error messages have a red background, warning messages a yellow background, and advisory messages a green background.

For more information

If any messages are encountered while running Self-Tests, refer to the Service Guide for information on test descriptions and troubleshooting procedures. If an error is encountered during analyzer configuration or general operation, there could be more than one cause of the problem. In most cases, the analyzer is configured improperly.

Error Messages

Must have at least 1 edge specified. You must assign at least one clock edge to one of the available clocks in the Master clocking arrangement. In addition, if the Slave clock is being used, it must have at least one clock edge assigned. The analyzer will not let you close the clock assignment pop-up until an edge is specified.

Time correlation of data is not possible. Before time correlation of data is possible, time tags must be placed on the data. If you want time correlated data, set the Count field in the Trigger menu to Time.

Maximum of 32 channels per label. This message appears when you try to assign more than 32 channels to a single label

NO DISK. There are no disks in the disk drives. You must place a disk into the disk drive before configurations can be loaded or stored.

Timer is off in sequence level. At least one sequence level has specified a timer as part of the sequence instruction and that timer is not turned on. The timer must be set to either Start, Pause, or Continue.

Timer is specified in sequence, but never started. A timer is specified somewhere in the sequence, but was not started. The timer must be set to Start. The timer can be set to Start in any sequence level.

Problems reading file. The user is trying to translate a configuration file that can not be opened a second time.

Inverse assembler not loaded - bad object code. Corrupt inverse assembler file. Try getting another copy of the inverse assembler file and loading that.

Insufficient memory to load IAL - load aborted. There is not a block of free memory large enough to load inverse assembler.

ASCII entry not available. The ASCII base is not available. You must use another base selection.

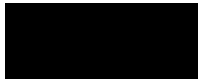

Warning Messages

Waiting for Prestore. This message is displayed for a timing analyzer waiting for prestore.

Search failed - X pattern not found. The X pattern specified could not be found; therefore, the pattern marker could not be placed in the data.

Search failed - O pattern not found. The O pattern specified could not be found, therefore the pattern marker could not be placed in the data.

Warning: Run HALTED due to variable change. This message appears when certain analyzer settings are changed during a repetitive run. When this occurs, the analyzer stops.

Error not found. The Find Error number specified could not be found.

s/Div set to limit. The s/Div field is set to its limit.

Delay set to limit. The Delay field is set to its limit.

Machine name: "al name" inverse assembler not found. This message appears when the inverse assembler file could not be found.

Slow or missing clock. This message indicates a slow or missing clock. This is displayed for a state analyzer only until the first clock occurs.

Data was acquired without time tags. Time tag values will not be displayed because data was stored without time tags. If you want time tags stamped on the data, set Count in the Trigger menu to Time.

Data was acquired without state tags. State tag values will not be displayed because data was stored without state tags. If you want state tags stamped on the data, set Count in the Trigger menu to State.

Two pod pairs are needed to use both timers. If both timers are being used in a single chip analyzer, and there are no spare chips, this message is shown when Run is selected. Timer2 references in the sequencer will not be valid.

No active analyzer. This message is displayed if Run is selected with no analyzers turned on.

Cannot read unrecognized data. The user is trying to translate a SPA configuration from a foreign module.

Demultiplexed clocking cannot be translated. The user is trying to translate a configuration that has demultiplexed or mixed clocks.

User thresholds have been truncated. The user is trying to translate a configuration having thresholds greater than 6 Volts or less than -6 Volts.

Slave clocks may need manual adjustment. The user is trying to translate an HP 16540/41A,D configuration which has slave clocks specified. This message appears when the translation is not direct.

Clock Qualifiers not fully restored. The user is trying to translate a configuration that has more than two qualifiers.

No state machines for this module. The user is trying to load an inverse assembler into a module with no state machines.

Error loading DISPLAY1. User is loading a configuration with a corrupt DISPLAY1 section.

Pods have been truncated. User is loading a configuration with number of chips greater than the current system's number of chips.

Clock pod and least significant pods have been preserved. User is loading a configuration with number of chips greater than the current system's number of chips

Need to have two free sequence levels. For each sequence level with a "<" assigned, you must leave two sequence levels free. To free up two levels, simply delete two levels.

Mixed Mode not available. User is trying to show mixed mode incorrectly.

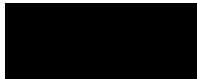

Error Messages
Warning Messages

Ymin is greater than Ymax. The value assigned to Y minimum is greater than the value assigned to Y maximum.

Xmin is greater than Xmax. The value assigned to X minimum is greater than the value assigned to X maximum.

Ymin is equal to Ymax. The value assigned to Y minimum is equal to the value assigned to Y maximum.

Xmin is equal to Xmax. The value assigned to X minimum is equal to the value assigned to X maximum.

Advisory Messages

Insert failed - Maximum of 60 entries. 60 listing columns is the maximum number allowed. This advisory appears when you try to configure more than 60 columns.

Occurrences Remaining in Level "n". The analyzer is waiting for the specified level to be satisfied. This advisory is used in analyzers that use the Occurs parameter.

Waiting in Level "n". The analyzer is waiting for the specified level to be satisfied. This advisory is used in analyzers that use the OR parameter.

n.nnn s remaining to delay. This advisory is displayed for a conventional/glitch timing analyzer that is doing a long hardware delay (after trigger and during the delay).

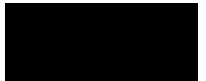

Specifications and
Characteristics



Specifications and Characteristics

This chapter lists specifications and characteristics for the HP 16556A and HP 16556D logic analyzers. Specifications are the performance standards against which the product is tested.

Characteristics are not specifications, but are included as additional information.

For complete information on the test procedures to verify product performance, refer to the *HP 16556A/D Logic Analyzers Service Guide*. The Service Guide is available through your Hewlett-Packard Sales Office.

Specifications

The specifications are the performance standards against which the product is tested. The HP 16556A/D requires HP 16500B operating system v3.03 or later to operate.

Minimum State Clock Pulse Width ¹	3.5 ns
Threshold Accuracy	± (100 mV + 3% of threshold setting)

Clock Scheme:

Single Clock, Single Edge:

Setup/Hold Time: ¹	0.0/3.5 ns through 3.5/0.0 ns, adjustable in 500-ps increments
-------------------------------	---

Maximum State Speed	100 MHz
---------------------	---------

Minimum Master-to-Master Clock Time ¹	10.0 ns
--	---------

Single Clock, Multiple Edges:

Setup/Hold Time: ¹	0.0/4.0 ns through 4.0/0.0 ns, adjustable in 500-ps increments
-------------------------------	---

Maximum State Speed	100 MHz
---------------------	---------

Minimum Master-to-Master Clock Time ¹	10.0 ns
--	---------

Multiple Clocks, Multiple Edges:

Setup/Hold Time: ¹	0.0/4.5 ns through 4.5/0.0 ns, adjustable in 500-ps increments
-------------------------------	---

Maximum State Speed	100 MHz
---------------------	---------

Minimum Master-to-Master Clock Time ¹	10.0 ns
--	---------

¹ Specified for an input signal $V_H = -0.9$ V, $V_L = -1.7$ V, and threshold = -1.3 V.

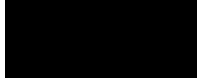

Characteristics

The characteristics are not specifications but are included as additional information.

HP 16556A

Maximum Conventional Timing Rate (1/2 Channel)	400 MHz
Maximum Conventional Timing Rate (full channel)	200 MHz
Channel Count Per Board	68
Maximum channel Count on One Time Base	340
Memory Depth (full channel)	1 M
Memory Depth (1/2 channel)	2 M

HP 16556D

Maximum Conventional Timing Rate (1/2 Channel)	400 MHz
Maximum Conventional Timing Rate (full channel)	200 MHz
Channel Count Per Board	68
Maximum channel Count on One Time Base	340
Memory Depth (full channel)	2 M
Memory Depth (1/2 channel)	4 M

Supplemental Characteristics

These characteristics are not specifications, but are included as additional information.

Probes

Input Resistance	100 K Ω , 2%
Input Capacitance	~ 8 pF
Minimum Voltage Swing	500 mV, peak-to-peak
Maximum Voltage Input	40 V, CAT I
Threshold Range	± 6.0 V, adjustable in 50 mV increments

State Analysis

Maximum State Clock Frequency	100 MHz
Setup/Hold Time ¹	0/3.5 ns through 3.5/0 ns, adjustable in 500 ps increments
Minimum State Clock Width	3.5 ns
State Clock/Qualifiers	4/4
Time Tag Resolution	10 ns
Maximum Time Count Between States	42 seconds
Maximum State Tag Count	4.29×10^9

¹Minimum setup/hold time specified for single-edge, single-clock acquisition. Single-clock, multiedge setup/hold window is 4 ns. Multiclock, multiedge setup/hold window is 4.5 ns. All setup/hold windows are adjustable in 500-ps increments.

Timing Analysis

Sample Period Accuracy	0.01 % of sample period
Channel-to-Channel Skew	2 ns, typical
Time Interval Accuracy	\pm (sample period + channel-to-channel skew + 0.01% of time interval reading)
Minimum Detectable Glitch	3.5 ns

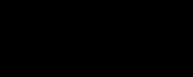

Specifications and Characteristics
Supplemental Characteristics

Triggering

Sequencer Speed	100 MHz, maximum
State Sequence Levels	12
Timing Sequence Levels	10
Max. Occurrence Counter Value	1,048,575
Pattern Recognizers	10
Range Recognizers	2
Range Width	32 bits each
Timers	2
Timer Value Range	400 ns to 500 seconds
Glitch/Edge Recognizers	2 (timing only)

Measurement and Display Functions

Arming Each module can be armed by the RUN key, external PORT IN, or by another module via the Intermodule Bus (IMB).

Displayed Waveforms 24 lines maximum, with scrolling across 96 waveforms.

Measurement Functions

Run/Stop Functions

Run Starts acquisition of data in specified trace mode.

Stop In single trace mode or the first run of a repetitive acquisition, STOP halts acquisition and displays the current acquisition data. For subsequent runs in repetitive mode, STOP halts acquisition of data and updates the current display.

Trace Mode Single mode acquires data once per trace specification. Repetitive mode repeats single mode acquisitions until stop is pressed or until time interval between two specified patterns is less than or greater than a specified value, or within or not within a specified range.

Indicators

Activity Indicators Provided in the Configuration and Format menus for identifying high, low, or changing states on the inputs.

Markers Two markers (X and 0) are shown as dashed lines on the display.

Trigger Displayed as a vertical dashed line in the Timing Waveform display and a line 0 in the State Listing display.

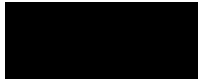

Data Entry/Display

Labels Channels may be grouped together and given a 6-character name. Up to 126 labels in each analyzer may be assigned with up to 32 channels per label.

Display Modes State listing, State Waveforms, Timing Waveforms, Timing Listings, Chart, Compare Reference Listing, Compare Difference Listing, and System Performance Analysis. State Listing, Timing Waveforms, and Oscilloscope Waveforms can be time-correlated on the same displays.

Timing Waveform Pattern readout of timing waveforms at X or 0 marker.

Bases Binary, Octal, Decimal, Hexadecimal, ASCII (display only), Two's Complement, and User-defined symbols.

Symbols 500 maximum. Symbols can be downloaded over RS-232 or HP-IB.

Marker Functions

Time Interval The X and 0 markers measure the time interval between one point on a timing waveform and trigger, two points on the same timing waveform, two points on different waveforms, or two states (time tagging on).

Delta States (state analyzer only) The X and 0 markers measure the number of tagged states between one state and trigger or between two states.

Patterns The X and 0 markers can be used to locate the nth occurrence of a specified pattern from trigger, or from the beginning of data. The 0 marker can also find the nth occurrence of a pattern from the X marker.

Statistics X and 0 marker statistics are calculated for repetitive acquisitions. Patterns must be specified for both markers, and statistics are kept only when both patterns can be found in an acquisition. Statistics are minimum X to 0 time, maximum X to 0 time, average X to 0 time, and ratio of valid runs to total runs.

Auxiliary Power

Power Through Cables 1/3 amp at 5 V maximum per cable

Operating Environment

Indoor Use Only

Temperature Instrument, 0 C to 55 C (+32 F to 131 F)
Probe lead sets and cables, 0 C to 65 C
(+32 F to 149 F).

Humidity Instrument, probe lead sets, and cables,
up to 95% relative humidity at +40 C
(+122 F)

Altitude To 4600 m (15,000 ft)

Vibration Operating: Random vibration 5-500 Hz, 10
minutes per axis, 0.3 g (rms)

Non-operating: Random vibration 5 to 500
Hz, 10 minutes per axis, 2.41 g (rms); and
swept sine resonant search, 5 to 500 Hz,
0.75 g (0-peak), 5 minute resonant dwell
at 4 resonances per axis.

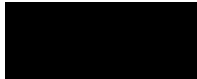

 
Installation

To configure a single-card module

- When shipped separately, the module is configured as a single-card module. The cables should be connected as shown in the figure.
- To configure a multi-card module into single-card modules, remove the cables connecting the cards. then connect the free end of the 2x10 cable on the connector labeled "Master" (J6) on each card (see figure below).

CAUTION

If you pull on the flexible ribbon part of the 2x10 cable, you might damage the cable assembly. Using your thumb and finger, grasp the ends of the cable connector. Apply pressure to the ends of the cable connector to disengage the metal locking tabs of the connector from the cable socket on the board. Then pull the connector from the cable socket.

Save unused cables for future configurations.

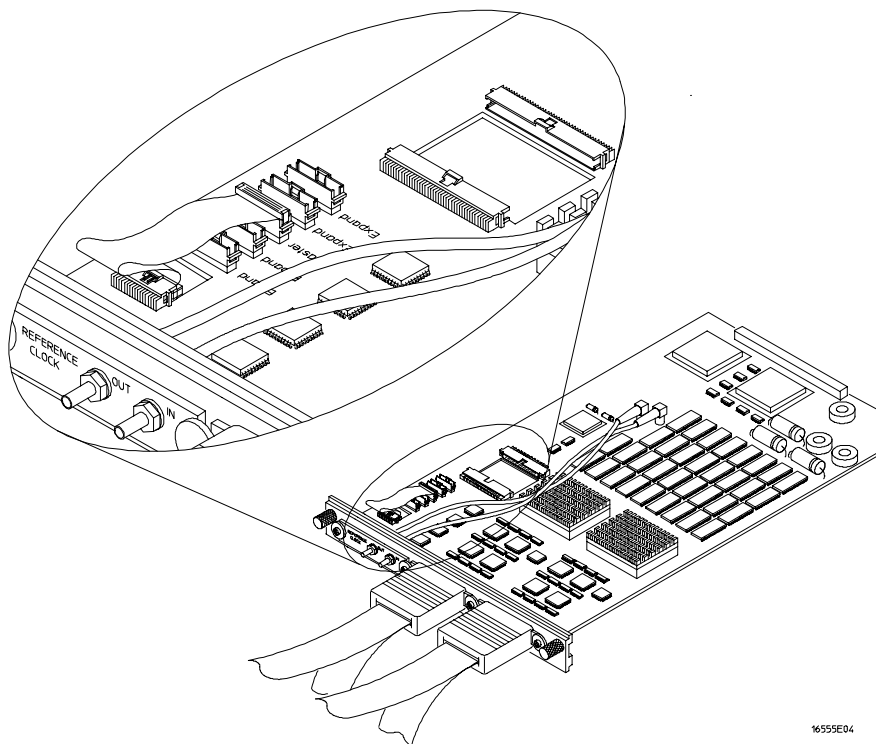

16555E04

To configure a multi-card module

- 1 Plan the configuration. multi-card modules can only be connected as shown in the illustration. Select the card that will be the master card, and set the remaining boards aside.
- 2 Obtain two 2x25 cables from the accessory pouch that match the

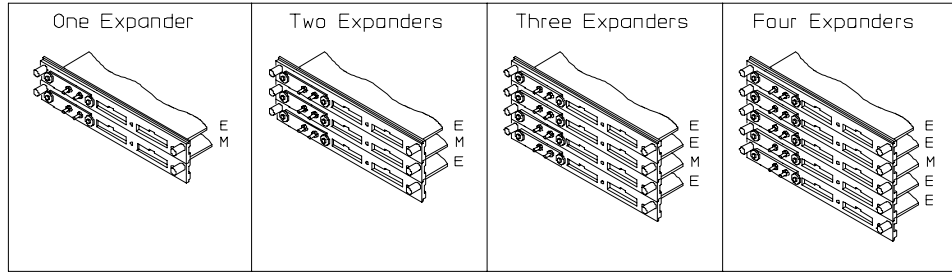

16559E06

number of expanders being configured. The illustration shows the cables that are available and which cable is used in each expander configuration.

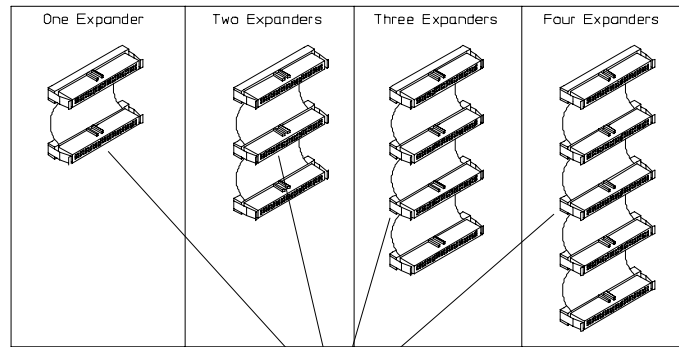

16559E09

This connector is plugged into the Master Card.

Installation
To configure a multi-card module

- 3 Look at the illustration in the previous step. The illustration shows which of the cable connectors is plugged into the master card. Plug one 2x25 cable into the master card J9. Observe which cable connector (as shown in the illustration) is plugged into J9. Follow the same procedure to connect the second 2x25 cable into the master card J10.

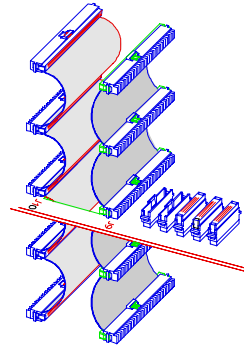

16555E10

- 4 On the expander cards, disconnect the end of the 2x10 cable that is plugged into the connector labeled "Master."

CAUTION

If you pull on the flexible ribbon part of the 2x10 cable, you might damage the cable assembly. Using your thumb and finger, grasp the ends of the cable connector. Apply pressure to the ends of the cable connector to disengage the metal locking tabs of the connector from the cable socket on the board. Then pull the connector from the cable socket.

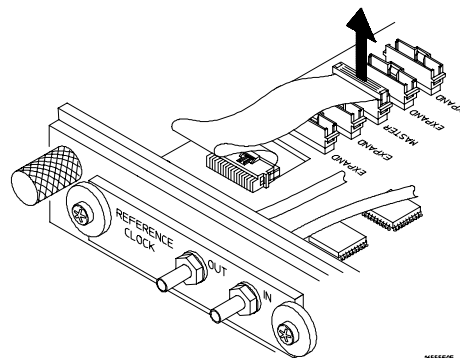

16555E06

- 5 Place the master card on top of any expander cards that are under the master card. Feed the 2x25 cables that are plugged into the master card through the cable access holes of the expander cards. Plug the 2x25 cables into J9 and J10 of the expander cards.

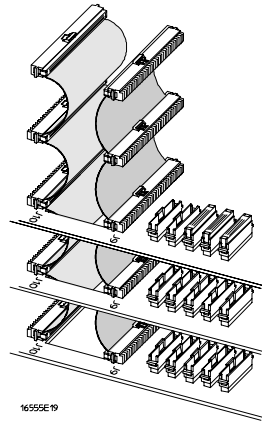

- 6 Feed the free end of the 2x10 cables of the expander cards through the access holes to the master card. Plug the 2x10 cables into J4 (bottom-most expander in a five-card configuration) and J5 (expander that is next to the master card) on the master card.

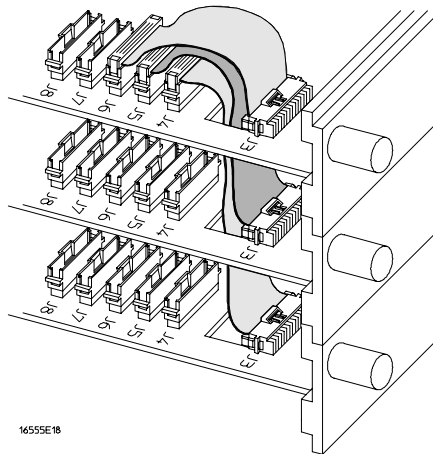

Installation
To configure a multi-card module

- 7 Place the remaining expander boards on top of the master board. Feed the 2x25 cables that are plugged into the master card through the cable access holes of the expander cards. Plug the 2x25 cables into J9 and J10 of the expander cards.

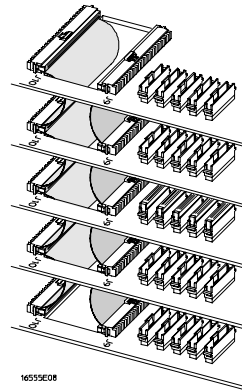

- 8 Feed the free end of the 2x10 cables of the expander cards through the access holes to the master card. Plug the 2x10 cables into J7 (expander that is next to the master card) and J8 (top-most expander in a four- or five-card configuration) on the master card.

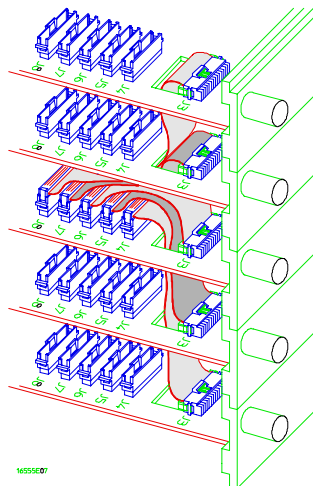

- 9 The following illustration shows the proper connection of the 2x25 cables and the 2x10 cables for a five card module. If a two-, three-, or four-card module was configured, not all cables will be present; however, the existing cables will be routed in the same manner. Make sure ALL cables are firmly seated.

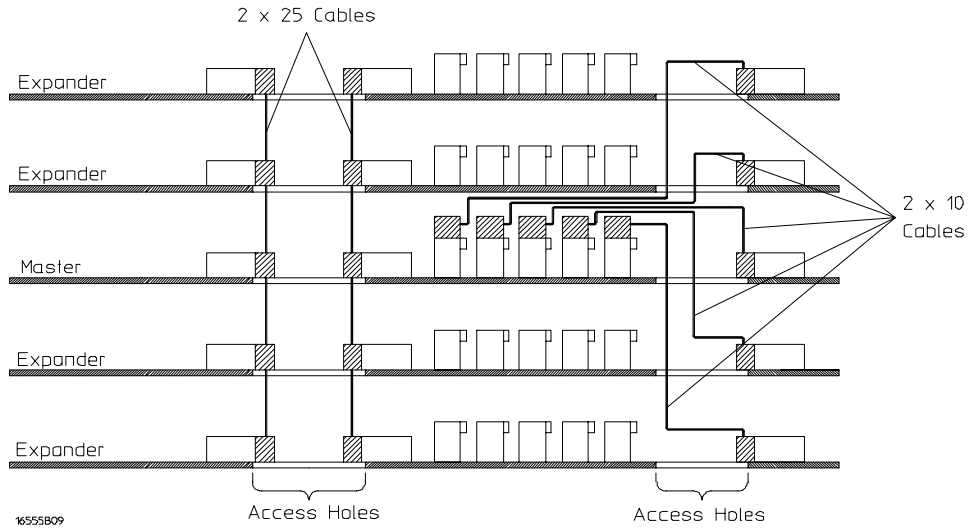

To install modules

- 1 Slide the cards which are above the slots into which you want to put modules about halfway out of the mainframe.
- 2 With the probe cables facing away from the instrument, slide the modules approximately halfway into the mainframe.

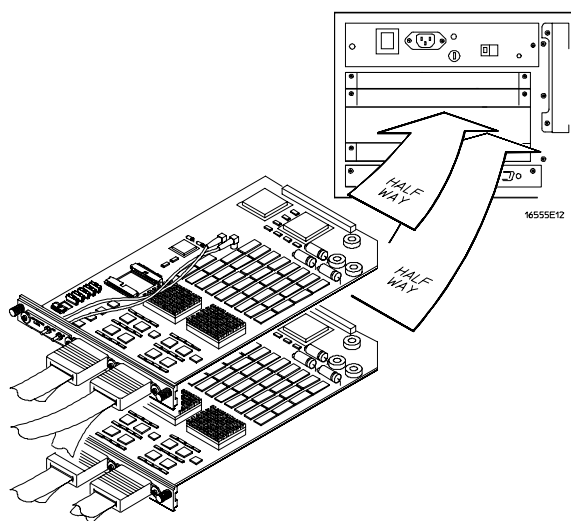

- 3 Slide the assembled modules into the mainframe, but not completely in.
Each card in the instrument will be firmly seated and tightened in step 5.
- 4 Position all cards and filler panels so that the endplates overlap.
- 5 Seat the cards and tighten the thumbscrews.

Starting with the bottom card, firmly seat the cards into the backplane connector of the mainframe. Keep applying pressure to the center of the card endplate while tightening the thumbscrews finger-tight. Repeat this for all cards and filler panels from the bottom up.

CAUTION

Correct air circulation keeps the instrument from overheating. For correct air circulation, filler panels must be installed in all unused card slots. Keep any extra filler panels for future use.

Preparing for Use

Power Requirements

All power supplies required for operating the logic analyzer are supplied through the backplane connector in the mainframe.

Operating System Requirements

The HP 16556 requires an HP 16500C logic analysis system mainframe or 16500B running version 3.10 or higher. It is not compatible with the HP 16500A. The HP 16500C mainframe must be running version 1.00 or later of the system software. If these requirements are not met, the HP 16556 module will not be recognized.

Operating Environment

The operating environment is listed in chapter 13. Note the non-condensing humidity limitation below. Condensation within the instrument can cause poor operation or malfunction. Provide protection against internal condensation.

The logic analyzer module will operate at all specifications within the temperature and humidity range given in chapter 13. However, reliability is enhanced when operating the module within the following ranges:

- Temperature: +20 °C to +35 °C (+68 °F to +95 °F)
- Humidity: 20% to 80% non-condensing

Storage

Store or ship the logic analyzer in environments within the following limits:

- Temperature: -40 °C to +75 °C
- Humidity: Up to 90% at 65 °C
- Altitude: Up to 15,300 meters (50,000 feet)

Protect the module from temperature extremes which cause condensation on the instrument.



To inspect the module

1 Inspect the shipping container for damage.

If the shipping container or cushioning material is damaged, keep them until you have checked the contents of the shipment and checked the instrument mechanically and electrically.

2 Check the supplied accessories.

Accessories supplied with the module are listed in chapter 1, "Accessories Supplied."

3 Inspect the product for physical damage.

Check the module and the supplied accessories for obvious physical or mechanical defects. If you find any defects, contact your nearest Hewlett-Packard Sales Office. Arrangements for repair or replacement are made, at Hewlett-Packard's option, without waiting for a claim settlement.

To clean the logic analyzer module

With the instrument turned off and unplugged, use mild soap and water to clean the front of the module. Harsh soap might damage the water-based paint.

A

- accessories
 - available 1-7
- accumulate field 7-5
- acquisition control
 - waveform menu 7-4
- acquisition control field
 - state analyzer 5-36
 - timing analyzer 5-36
- acquisition mode
 - automatic 5-37
 - manual 5-37
- action insert/replace field 7-26
- activity indicators 3-8
- advisory messages 12-2, 12-7
- analyzer name field 3-3
- analyzer type
 - state 3-4
 - state compare 3-4
 - timing 3-4
- Arm-In signal 5-33
- arming
 - intermodule 5-33
- arming between modules 5-33
- arming configuration 5-32
- arming control
 - between analyzers 5-32
 - graphical representation 5-32
- arming control field 5-31
- arming external instrument 5-33
- assignment field indicators 5-27
- asynchronous clock 3-4
- auto-range 11-5, 11-16
- auxiliary power characteristics 13-8
- avg time statistic 11-16

B

- bar chart 11-4
- base field 6-11, 7-19
- basic controls 7-3
- bit assignment field 4-17
- bit editing field 9-15
- bit pattern assignment 5-20
- bit pattern terms 5-20
- blind time 11-9
- blue bar field 7-23
- branches taken field 5-39
- branching
 - across trigger levels 5-13

- edge terms 5-26
 - secondary term 5-13
- branching field 5-13
- buckets 11-4
- bus interfaces 2-4

C

- center screen field 7-15
- changing between
 - SPA and a State/Timing Analyzer 11-30
- channel depth, maintain 4-3
- channel masking 9-10
- channel mode
 - full 4-6
 - half 4-6
 - individual 7-24
 - overlay 7-25
 - sequential 7-25
- channel mode field 7-24
- channels
 - clock 1-2
 - data 1-2
- characteristics, listed 13-4
- characteristics 13-2
 - auxiliary power 13-8
 - data entry and display 13-7
 - measurement 13-6
 - measurement and display 13-6
 - operating environment 13-8
 - probe 13-4
 - state analysis 13-4
 - timing analysis 13-4
 - triggering 13-5
- chart menu 8-2
 - find o-pattern field 8-6
 - find x-pattern field 8-6
 - from trigger/start/x-marker field 8-7
 - label and base fields 8-9
 - label/base roll field 8-9
 - markers field 8-5
 - occurrence field 8-6
 - post-processing features 8-2
 - specify patterns field 8-8
 - stop measurement field 8-10
 - x-axis label/state value field 8-16
- charts
 - label value vs label value 8-3
 - label value vs states 8-3
- choosing a label to monitor 11-21

- clear pattern field 6-14
- clock
 - asynchronous 3-4
 - input channels 4-5
 - master 4-2, 4-5, 4-7, 4-11
 - qualifier 4-2
 - reference 5-38
 - slave 4-2, 4-7 - 4-8, 4-11
 - synchronous 3-4
 - threshold levels 4-2
- clock combinations 4-12
- clock inputs
 - multicard 4-11
- clock input channel
 - as data channel 4-5
- clock inputs
 - single card 4-11
- clock qualifiers 4-12
- clock threshold level 4-12
- clock/qualifier 4-11
- clocking
 - preprocessor 2-4
 - select 3-2
- clocking modes 1-2
- combination assignment 5-28
- combination terms 5-28
- compare full/compare partial field 9-9
- compare image 9-4
- compare menu 9-2
 - bit editing field 9-15
 - compare full/compare partial field 9-9
 - copy trace to compare field 9-7
 - data roll field 9-14
 - difference listing field 9-5 - 9-6
 - find error field 9-8
 - label and base fields 9-16
 - label/base roll field 9-16
 - mask field 9-10
 - post-processing features 9-3
 - reference listing field 9-4
 - specify stop measurement 9-11 - 9-13
- configuration 1-4
- configuration file 1-7
- configuration menu 3-2
- configure
 - one-card module 14-2
- configure a multicard module 14-3 - 14-7
- control field
 - arming 5-31

-
- control fields 5-30
 - controls
 - basic 7-3
 - copy trace to compare field 9-7
 - count field 5-34
 - counters 1-2
 - cross-domain measurements 5-31
 - current sample 7-9
 - D**
 - data
 - acquired 6-2
 - interleaved 6-2
 - scrolling 7-8
 - state 7-2
 - timing 7-2
 - data entry and display characteristics 13-7
 - data roll field 6-19, 9-14
 - data sorting 11-8
 - and sampling 11-10, 11-12, 11-15
 - default timer 5-15
 - delay 5-38
 - delay field 7-8
 - delay range 7-8
 - delete and delete all fields 7-27
 - demultiplex mode 4-7 - 4-8
 - demultiplexing
 - preprocessor 2-4
 - difference listing field 9-5 - 9-6
 - display
 - zoom 7-6 - 7-7
 - display hidden data 6-19
 - displays
 - time-correlated 10-5
 - E**
 - ECL 4-10
 - edge assignment 5-26
 - edge choices 5-26
 - edge term symbols 5-27
 - edge terms 5-26
 - error messages 12-2 - 12-3
 - examples
 - State Histogram mode 11-14
 - State Overview mode 11-11
 - Time Interval mode 11-17
 - expander card
 - using all three trace modes 11-18
 - expander card
 - cabling 14-4
 - expander cards 14-3
 - F**
 - features 1-5
 - file configuration
 - preprocessor 2-5
 - file translation
 - preprocessor 2-5
 - find error field 9-8
 - find x-pattern/find o-pattern field 8-6
 - find X-pattern/O-pattern 6-5
 - format menu 4-2
 - from start X-marker field 6-7, 7-14
 - from trigger field 7-14
 - from trigger X-marker field 6-7
 - from trigger/start/x-marker field 8-7
 - G**
 - grabbers
 - connecting to probes 2-24
 - connecting to test points 2-24
 - probe 2-19
 - grounding
 - pod 2-18
 - probe 2-18
 - group run 10-2 - 10-4
 - H**
 - histograms 11-4
 - HP 10269C General Purpose Probe Interface 1-7
 - I**
 - indicators 13-6
 - individual channel mode 7-24
 - inserting waveforms 10-4
 - install a multcard module 14-3 - 14-7
 - installation
 - one-card module 14-2
 - installing modules 14-8
 - installing probe leads 2-23
 - interface
 - preprocessor 2-4
 - universal 2-4
 - interface kit
 - probing 2-3
 - interleaved state listings 10-4
 - intermodule configuration 10-3
 - intermodule menu 10-2
 - inverse assembler 1-7
 - preprocessor 2-4
 - K**
 - keyboard 1-3
 - L**
 - label field 6-11, 7-19
 - label polarity 4-16
 - labels 11-9
 - changing 11-9
 - selecting 11-9
 - State Histogram Mode 11-9
 - State Overview Mode 11-9
 - Time Interval mode 11-9
 - leads
 - probe 2-19
 - listing menu 6-2
 - M**
 - macro library 5-3
 - macros
 - predefined 5-3
 - state trigger 5-7
 - timing trigger 5-5
 - user defined 5-3
 - macros, predefined
 - how to use 5-4
 - markers
 - chart menu 8-4
 - color 6-4
 - field 6-3
 - in mixed display 10-5
 - in waveform display 7-12
 - O 11-10
 - pattern 7-12
 - state analyzer 6-3, 7-11
 - timing analyzer 6-3, 7-11
 - markers field 7-11, 8-5
 - mask field 9-10
 - master card 14-3
 - cabling 14-4
 - master clock 4-2, 4-11
-

-
- max time statistics 11-16
 - measurement and display characteristics 13-6
 - measurement characteristics 13-6
 - measurements
 - cross-domain 5-31
 - memory
 - reference line 7-23
 - memory contents
 - posttrigger data 5-37
 - pretrigger data 5-37
 - memory depth 1-2, 4-4
 - memory depth considerations 5-35
 - memory length field 5-38
 - menu
 - configuration 3-2
 - format 4-2
 - listing 6-2
 - resource term configuration 5-17
 - sequence instruction 5-11
 - trigger 5-2
 - waveform 7-2
 - menus
 - accessing SPA 11-6
 - messages
 - advisory 12-2, 12-7
 - error 12-2
 - warning 12-2, 12-4 - 12-6
 - microprocessor mnemonics 2-4
 - min time statistics 11-16
 - mixed display markers 10-5
 - mixed display menu 10-2
 - mnemonics
 - microprocessor 2-4
 - Modify trigger field 5-40 - 5-42
 - module
 - and label fields 7-26
 - cleaning 14-10
 - definition 1-4
 - installation 14-8
 - requirements 14-9
 - mouse 1-3
 - multicard
 - reference clock 5-38
 - multicard module 4-5
 - multicard module, configure 14-3 - 14-7
- N**
- name field 3-3
 - naming analyzers 3-3
 - next sample 7-9
 - number of samples per range 11-13
- O**
- O marker field 6-9
 - O-pattern occurrence field 7-13
 - occurrence counter
 - reference point 7-13
 - occurrence counter field 5-12
 - occurrence field 8-6
 - occurrences
 - maximum number 5-12
 - occurrences, number of 5-34
 - one-card module
 - configuration 14-2
 - operating environment characteristics 13-8
 - Other States included/excluded 11-5, 11-13
 - overlay channel mode 7-25
- P**
- pattern display fields 6-10
 - pattern markers 6-4, 7-12
 - color 7-12
 - pattern occurrence
 - fields 6-6
 - reference point 6-6
 - performance verification 13-2
 - plot from State 8-17
 - pod clock field 4-7
 - pod connections
 - preprocessor 2-5
 - pod field 4-6
 - pod grounding 2-18
 - pod scrolling box 3-6
 - pod threshold field 4-10
 - pod voltage thresholds 2-20
 - Pods
 - assign 3-2
 - unassigned 3-6
 - polarity
 - default 4-16
 - label 4-16
 - Port-Out signal 5-33
 - post-processing features
 - chart menu 8-2
 - compare menu 9-3
 - posttrigger data 5-37
 - predefined resource terms
 - combination 5-28
 - predefined resource terms
 - selection 5-28
 - preprocessor file configuration 2-5
 - preprocessor modules 1-7
 - preprocessor pod connections 2-5
 - pretrigger data 5-37
 - probe
 - grabbers 2-19
 - leads 2-19
 - probe cable 2-20
 - power caution 2-20
 - probe cables
 - connecting 2-22
 - probe characteristics 13-4
 - probe grounding 2-18
 - probe input voltage
 - maximum 2-20
 - probe interface 2-3
 - probe leads
 - disconnecting 2-23
 - installing 2-23
 - probe tip assembly
 - connecting 2-17
 - probes
 - connecting grabbers 2-24
 - probing
 - general purpose 2-2, 2-17
 - options 2-2
 - passive 2-17
 - system components 2-21
 - product performance, verify 13-2
- R**
- range assignment 5-22
 - range specifiers 11-12
 - range terms 1-2, 5-22
 - reference clock 1-4, 2-25, 5-38
 - reference listing field 9-4
 - repetitive mode 7-5
 - resource terms 1-2, 5-9, 5-16, 5-41
 - combine 5-12
 - field 5-17
 - menu 5-17
-

S

- sample period
 - Time Interval mode, minimum 11-5
 - sample period display 7-9
 - sample period field 5-39
 - sampling methods
 - blind time 11-9
 - scrolling data 7-8
 - seconds per division field 7-7
 - select new macro field 5-12
 - selecting
 - SPA modes 11-6
 - State Histogram mode 11-6
 - State Overview mode 11-6
 - Time Interval mode 11-6
 - selecting fields
 - display 11-21
 - sequence instruction menu 5-11
 - sequence instructions
 - stored data 5-39
 - sequence level
 - insert, delete 5-12
 - sequence level number field 5-10
 - sequence levels 1-2, 5-9, 5-41
 - sequence of instructions 5-9
 - sequential channel mode 7-25
 - setting up
 - logic analyzer (SPA) 11-21
 - State Format specification 11-7
 - setup and hold
 - default 4-14
 - setup and hold adjustments 4-13
 - signal amplitude
 - probing 2-20
 - single mode 7-5
 - single-card module 4-5
 - slave clock 4-2, 4-11
 - SPA
 - See System Performance Analysis
 - specifications 13-2
 - specifications, listed 13-3
 - specify patterns field 6-8, 7-16, 8-8
 - Specify States field 11-13
 - specify stop measurement 9-11 - 9-13
 - compare 9-12
 - x - o 9-13
 - specifying low and high values 11-22
 - start/end conditions 11-15
 - state acquisition mode 4-3
 - state analysis characteristics 13-4
 - state analyzer 3-4
 - state analyzer markers 7-11
 - state analyzers
 - vs SPA 11-4
 - state compare 3-4
 - State Format specification
 - setting up 11-7
 - State Histogram mode 11-5, 11-12
 - All States vs Qualified States 11-13
 - choosing a label to monitor 11-24
 - data sampling and sorting 11-12
 - defining the ranges 11-24
 - example 11-14
 - interpreting the histogram display 11-26
 - maximum number of ranges 11-5
 - number of samples per range 11-13
 - operating characteristics 11-5
 - Other States included/excluded 11-13, 11-26
 - range specifiers 11-12
 - selecting 11-6
 - State Histogram vs State Overview 11-12
 - total samples 11-13
 - tracing All States vs Qualified States 11-25
 - user-defined ranges vs symbols 11-13
 - using 11-24
 - using symbols for ranges 11-25
 - state listings
 - interleaved 10-4
 - viewing 10-2
 - state listings from other analyzers 10-4
 - State Overview mode 11-4, 11-9
 - choosing a label to monitor 11-21
 - data sampling and sorting 11-10
 - example 11-11
 - interpreting the histogram display 11-23
 - operating characteristics 11-4
 - selecting 11-6
 - specifying low and high values 11-22
 - total count 11-10
 - using 11-21
 - using the markers 11-23
 - X axis scaling 11-9
 - Y axis scaling 11-10
 - zooming in on an area of interest 11-23
 - state tags 4-3, 5-34
 - absolute 5-34
 - relative 5-34
 - states per division 7-2
 - states per division field 7-6
 - statistical information 7-20
 - statistics markers 6-17, 7-20
 - color 6-17
 - in a state analyzer 7-20
 - in repetitive run mode 6-18
 - in single run 7-21
 - in single run mode 6-18
 - repetitive run 7-21
 - state analyzer 6-17
 - status lines
 - preprocessor 2-4
 - stop measurement
 - x - o 8-11
 - X-O option 6-13
 - stop measurement field 6-12, 8-10
 - symbols 4-2
 - synchronous clock 3-4
 - System Performance Analysis 3-5
 - definition 11-4
 - operating characteristics 11-4
 - using with other features 11-30
- T**
- tags
 - state 4-3
 - time 4-3
 - template 9-4
 - term assignment field 5-12
 - termination adapter 2-3
 - terms
 - resource 5-16
 - test points
 - connecting grabbers 2-24
 - test procedures
 - verify product performance 13-2
 - Time Interval mode 11-5, 11-15
 - auto-range 11-16
 - data sampling and sorting 11-15
 - defining the time interval ranges 11-28
 - example 11-17
 - interpreting the histogram display 11-28
 - operating characteristics 11-5
 - resolution 11-5
 - selecting 11-6

-
- specifying an event 11-27
 - start/end conditions 11-15
 - time statistics 11-16
 - total samples 11-16
 - using 11-27
 - using Auto-range 11-28
 - Time interval ranges 11-16
 - maximum time 11-16
 - minimum time 11-16
 - range of 11-5
 - time markers 7-17
 - color 6-15
 - in a state analyzer 7-17
 - state analyzer 6-15
 - timing analyzer 6-15
 - with pattern markers 7-17
 - time per division 7-2
 - time statistics 11-16
 - time tags 4-3, 5-35
 - absolute 5-35
 - relative 5-35
 - resolution 5-35
 - time-correlated displays 10-5
 - timer
 - minimum value 5-25
 - timer assignment 5-24
 - timer control field 5-15
 - timer status 5-10
 - timer terms 5-24
 - inverted 5-24
 - within sequence level 5-24
 - timer, default 5-15
 - timers 1-2
 - timing acquisition mode 4-4
 - timing analysis characteristics 13-4
 - timing analyzer 3-4
 - vs SPA 11-4
 - timing analyzer markers 7-11
 - timing waveforms reconstructed 7-10
 - total count
 - State Overview 11-5, 11-10
 - total samples
 - State Histogram mode 11-13
 - Time Interval mode 11-16
 - trace modes 11-8
 - selecting 11-8
 - State Histogram 11-8
 - State Overview 11-8
 - Time Interval 11-8
 - trace type
 - All States vs Qualified States 11-13
 - translation information
 - table 2-6
 - trig to O field 7-18
 - trig to X field 7-18
 - trig to X/trig to O fields 6-16
 - trigger menu 5-2
 - trigger point placement 5-37
 - trigger position
 - center 5-38
 - end 5-38
 - start 5-37
 - user defined 5-38
 - trigger position field 5-37
 - triggering characteristics 13-5
 - TTL 4-10
- U**
- unassigned pods 3-6
 - user-defined macros 5-3
- V**
- valid data
 - clock position in 4-14
 - viewing state listings 10-2
 - voltage level
 - user selected 4-10
- W**
- warning messages 12-2, 12-4 - 12-6
 - waveform display 7-22
 - waveform menu 7-2
 - acquisition control 7-4
 - basic controls 7-3
 - waveforms
 - inserting 10-4
- X**
- X and O entering/ leaving fields 6-9
 - X and O markers 11-10
 - O Mark count 11-10
 - X Mark count 11-10
 - X axis 11-4, 11-9
 - high value 11-9
 - low value 11-9
 - X marker field 6-9
 - X to O display field 6-16
 - X to O field 7-18
 - in state analyzer 7-18
 - in timing analyzer 7-18
 - X-axis label/state value field 8-16
 - X-pattern occurrence field 7-13
- Y**
- Y axis 11-5, 11-10
 - maximum value 11-5
- Z**
- zoom 7-6 - 7-7
-

DECLARATION OF CONFORMITY

according to ISO/IEC Guide 22 and EN 45014

Manufacturer's Name: Hewlett-Packard Company

Manufacturer's Address: Colorado Springs Division
1900 Garden of the Gods Road
Colorado Springs, CO 80907 USA

declares, that the product

Product Name: Logic Analyzer Module

Model Number(s): HP 16556A/D

Product Option(s): All

conforms to the following Product Specifications:

Safety: IEC 1010-1:1990+A1 / EN 61010-1:1993
UL 3111
CSA-C22.2 No. 1010.1:1993

EMC: CISPR 11:1990 / EN 55011:1991 Group 1 Class A
IEC 555-2:1982 + A1:1985 / EN 60555-2:1987
IEC 555-3:1982 + A1:1990 / EN 60555-3:1987 + A1:1991
IEC 801-2:1991 / EN 50082-1:1992 4 kV CD, 8 kV AD
IEC 801-3:1984 / EN 50082-1:1992 3 V/m, {1kHz 80% AM, 27-1000 MHz}
IEC 801-4:1988 / EN 50082-1:1992 0.5 kV Sig. Lines, 1 kV Power Lines

Supplementary Information:

The product herewith complies with the requirements of the Low Voltage Directive 73/23/EEC and the EMC Directive 89/336/EEC and is marked accordingly.

This product was tested in a typical configuration with Hewlett-Packard test systems.

Colorado Springs, 06/10/96

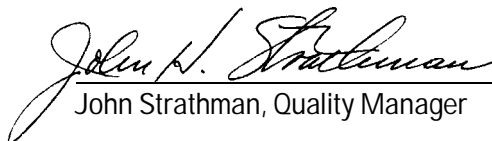
John Strathman, Quality Manager

European Contact: Your local Hewlett-Packard Sales and Service Office or Hewlett-Packard GmbH, Department ZQ / Standards Europe, Herrenberger Strasse 130, D-71034 Böblingen Germany (FAX: +49-7031-14-3143)

Product Regulations

Safety IEC 1010-1:1990+A1 / EN 61010-1:1993
UL 3111
CSA-C22.2 No.1010.1:1993

EMC This Product meets the requirement of the European Communities (EC)
EMC Directive 89/336/EEC.



Emissions EN55011/CISPR 11 (ISM, Group 1, Class A equipment)

Immunity	EN50082-1	Code ¹	Notes ²
	IEC 555-2	1	
	IEC 555-3	1	
	IEC 801-2 (ESD) 4kV CD, 8kV AD	2,1	A
	IEC 801-3 (Rad.) 3 V/m	1	A
	IEC 801-4 (EFT) 0.5 kV, 1kV	1,1	B

¹ Performance Codes:

- 1 PASS - Normal operation, no effect.
- 2 PASS - Temporary degradation, self recoverable.
- 3 PASS - Temporary degradation, operator intervention required.
- 4 FAIL - Not recoverable, component damage.

² Notes:

- A 0.5 V logic threshold with all cables disconnected
- B 0.5 V logic threshold with HP-IB cable connected

Sound Pressure Level N/A

© Copyright Hewlett-Packard Company 1991-1999
All Rights Reserved.

Reproduction, adaptation, or translation without prior written permission is prohibited, except as allowed under the copyright laws.

Restricted Rights Legend

Use, duplication, or disclosure by the U.S. Government is subject to restrictions set forth in subparagraph (C) (1) (ii) of the Rights in Technical Data and Computer Software Clause in DFARS 252.227-7013.

Hewlett-Packard Company,
3000 Hanover Street, Palo Alto, CA 94304 U.S.A.
Rights for non-DOD U.S. Government Departments and Agencies are set forth in FAR 52.227-19(c)(1,2).

Document Warranty

The information contained in this document is subject to change without notice.

Hewlett-Packard makes no warranty of any kind with regard to this material, including, but not limited to, the implied warranties of merchantability or fitness for a particular purpose.

Hewlett-Packard shall not be liable for errors contained herein or for damages in connection with the furnishing, performance, or use of this material.

Safety

This apparatus has been designed and tested in accordance with IEC Publication 348, Safety Requirements for Measuring Apparatus, and has been supplied in a safe condition. This is a Safety Class I instrument (provided with terminal for protective earthing). Before applying power, verify that the correct safety precautions are taken (see the following warnings). In addition, note the external markings on the instrument that are described under "Safety Symbols."

Warning

- Before turning on the instrument, you must connect the protective earth terminal of the instrument to the protective conductor of the (mains) power cord. The mains plug shall only be inserted in a socket outlet provided with a protective earth contact. You must not negate the protective action by using an extension cord (power cable) without a protective conductor (grounding). Grounding one conductor of a two-conductor outlet is not sufficient protection.
- Only fuses with the required rated current, voltage, and specified type (normal blow, time delay, etc.) should be used. Do not use repaired fuses or short-circuited fuseholders. To do so could cause a shock of fire hazard.

- Service instructions are for trained service personnel. To avoid dangerous electric shock, do not perform any service unless qualified to do so. Do not attempt internal service or adjustment unless another person, capable of rendering first aid and resuscitation, is present.

- If you energize this instrument by an auto transformer (for voltage reduction), make sure the common terminal is connected to the earth terminal of the power source.

- Whenever it is likely that the ground protection is impaired, you must make the instrument inoperative and secure it against any unintended operation.

- Do not operate the instrument in the presence of flammable gasses or fumes. Operation of any electrical instrument in such an environment constitutes a definite safety hazard.

- Do not install substitute parts or perform any unauthorized modification to the instrument.

- Capacitors inside the instrument may retain a charge even if the instrument is disconnected from its source of supply.

- Use caution when exposing or handling the CRT. Handling or replacing the CRT shall be done only by qualified maintenance personnel.

Safety Symbols



Instruction manual symbol: the product is marked with this symbol when it is necessary for you to refer to the instruction manual in order to protect against damage to the product.



Hazardous voltage symbol.



Earth terminal symbol: Used to indicate a circuit common connected to grounded chassis.

WARNING

The Warning sign denotes a hazard. It calls attention to a procedure, practice, or the like, which, if not correctly performed or adhered to, could result in personal injury. Do not proceed beyond a Warning sign until the indicated conditions are fully understood and met.

CAUTION

The Caution sign denotes a hazard. It calls attention to an operating procedure, practice, or the like, which, if not correctly performed or adhered to, could result in damage to or destruction of part or all of the product. Do not proceed beyond a Caution symbol until the indicated conditions are fully understood or met.

Hewlett-Packard
P.O. Box 2197
1900 Garden of the Gods Road
Colorado Springs, CO 80901-2197, U.S.A.

Product Warranty

This Hewlett-Packard product has a warranty against defects in material and workmanship for a period of one year from date of shipment. Some newly manufactured products may contain remanufactured parts which are equivalent to new in performance. During the warranty period, Hewlett-Packard Company will, at its option, either repair or replace products that prove to be defective. For warranty service or repair, this product must be returned to a service facility designated by Hewlett-Packard.

For products returned to Hewlett-Packard for warranty service, the Buyer shall prepay shipping charges to Hewlett-Packard and Hewlett-Packard shall pay shipping charges to return the product to the Buyer. However, the Buyer shall pay all shipping charges, duties, and taxes for products returned to Hewlett-Packard from another country.

Hewlett-Packard warrants that its software and firmware designated by Hewlett-Packard for use with an instrument will execute its programming instructions when properly installed on that instrument. Hewlett-Packard does not warrant that the operation of the instrument software, or firmware will be uninterrupted or error free.

Limitation of Warranty

The foregoing warranty shall not apply to defects resulting from improper or inadequate maintenance by the Buyer, Buyer-supplied software or interfacing, unauthorized modification or misuse, operation outside of the environmental specifications for the product, or improper

site preparation or maintenance.

No other warranty is expressed or implied. Hewlett-Packard specifically disclaims the implied warranties of merchantability or fitness for a particular purpose.

Exclusive Remedies

The remedies provided herein are the buyer's sole and exclusive remedies. Hewlett-Packard shall not be liable for any direct, indirect, special, incidental, or consequential damages, whether based on contract, tort, or any other legal theory.

Assistance

Product maintenance agreements and other customer assistance agreements are available for Hewlett-Packard products.

For any assistance, contact your nearest Hewlett-Packard Sales Office.

Certification

Hewlett-Packard Company certifies that this product met its published specifications at the time of shipment from the factory. Hewlett-Packard further certifies that its calibration measurements are traceable to the United States National Institute of Standards and Technology, to the extent allowed by the Institute's calibration facility, and to the calibration facilities of other International Standards Organization members.

About this edition

This is the *HP 16556AD 100-MHz State/400-MHz Timing Logic Analyzer User's Reference*.

Publication number
16556-97007, February 1999
Printed in USA.

Print history is as follows:
16556-97003, August 1996
16556-97006, August 1997

New editions are complete revisions of the manual. Many product updates do not require manual changes and manual corrections may be done without accompanying product changes. Therefore, do not expect a one-to-one correspondence between product updates and manual updates.